



CITY

4643



1

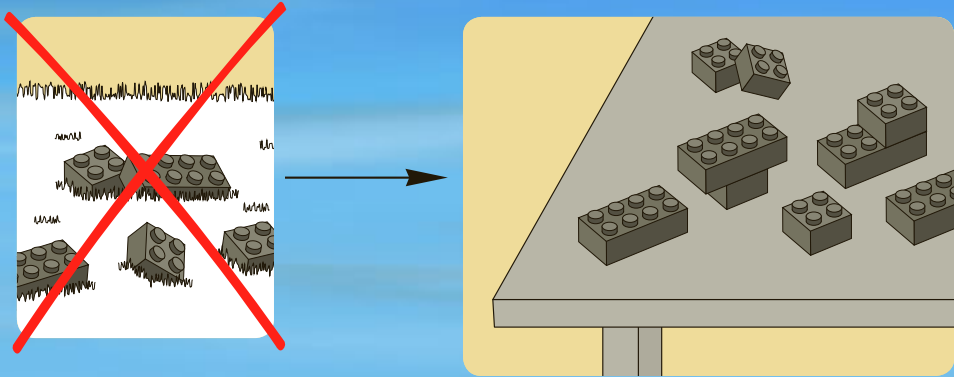

2

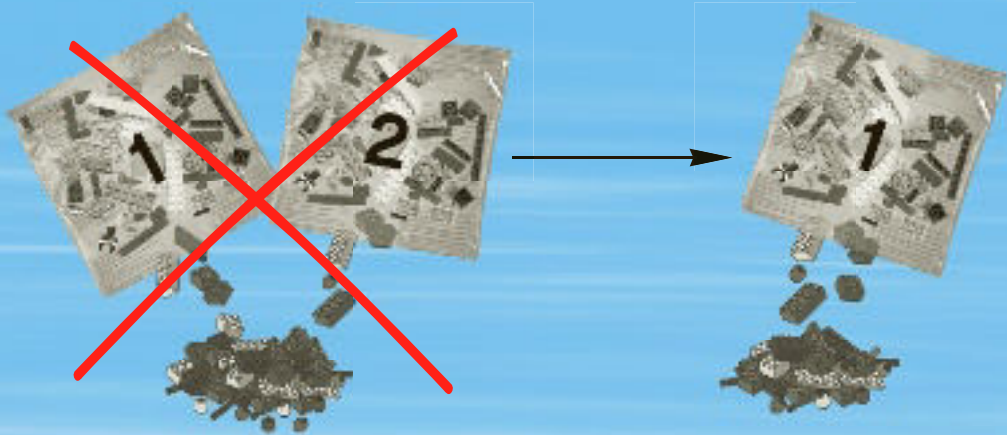



+

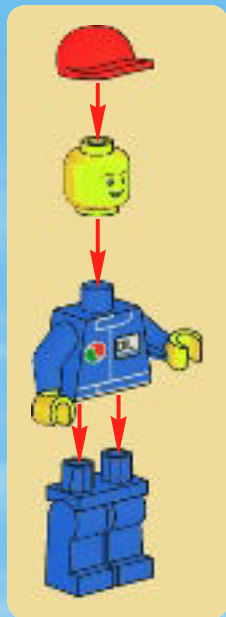

1

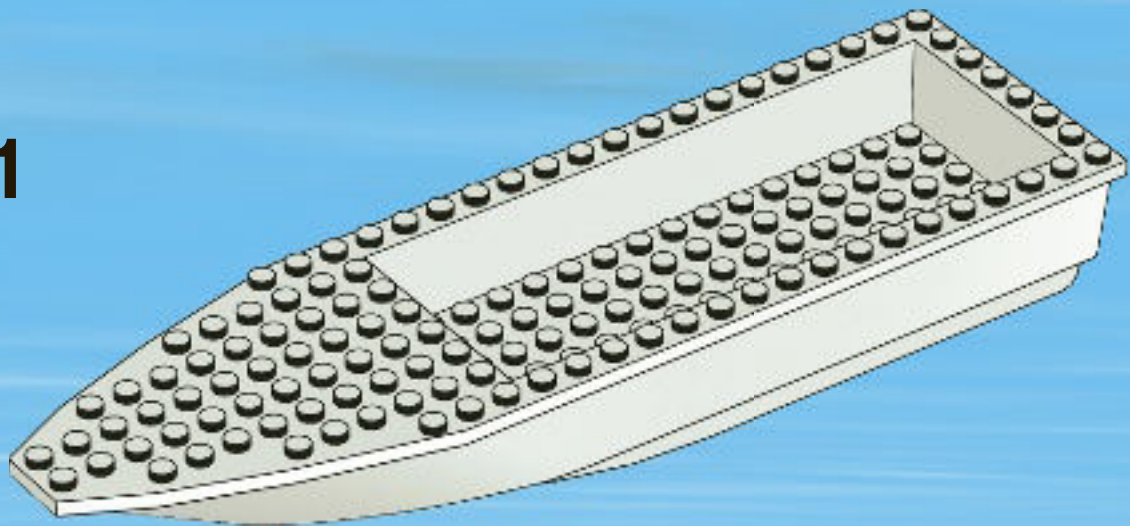

2

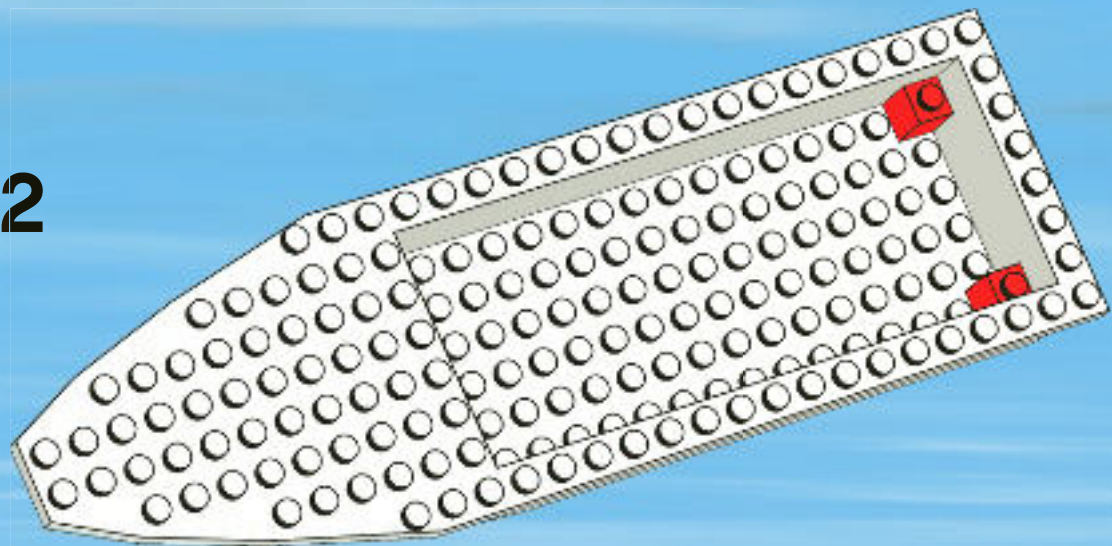

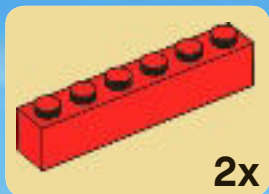

3

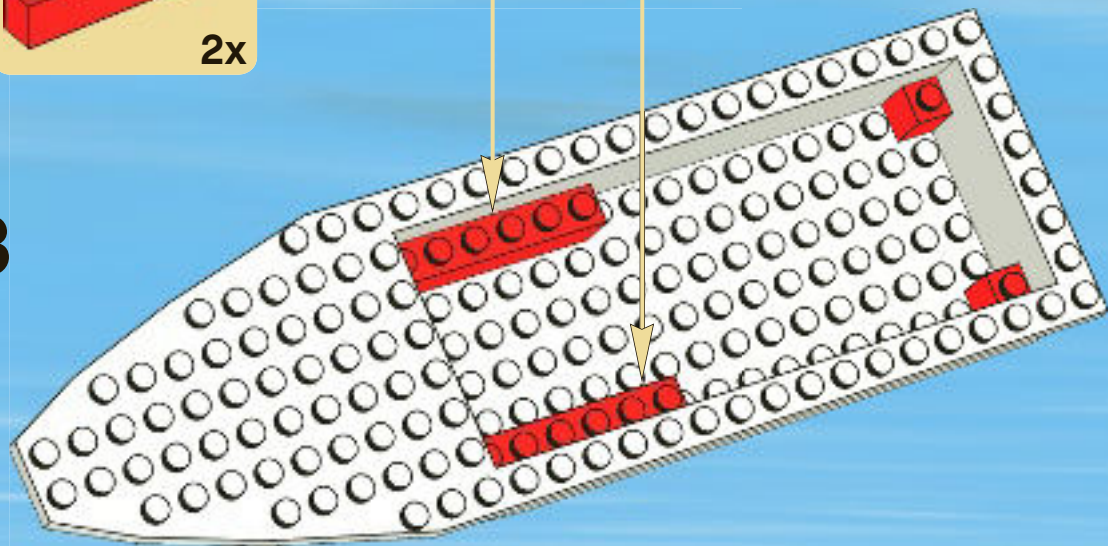

4

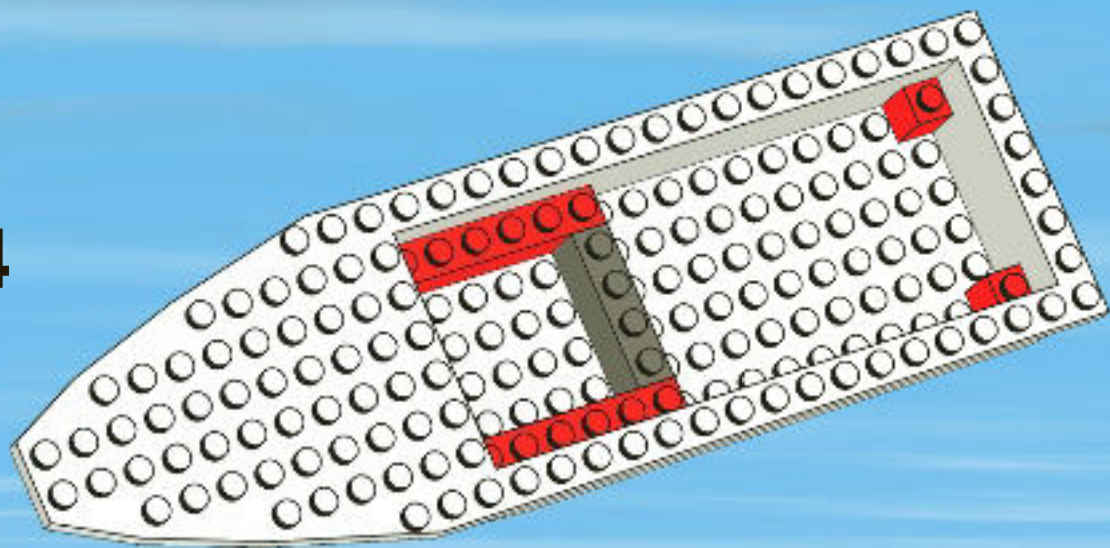

5

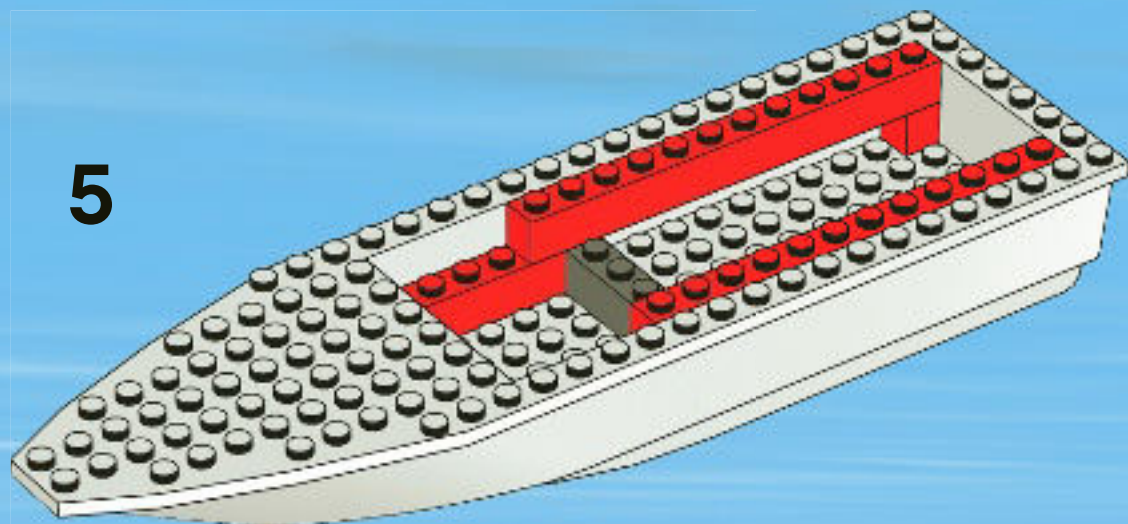

6

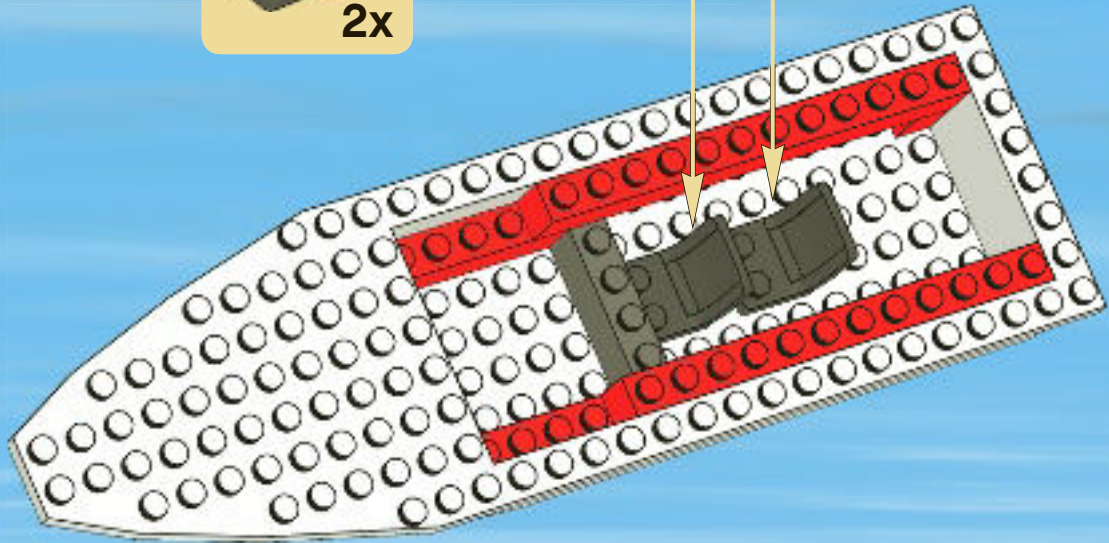

7

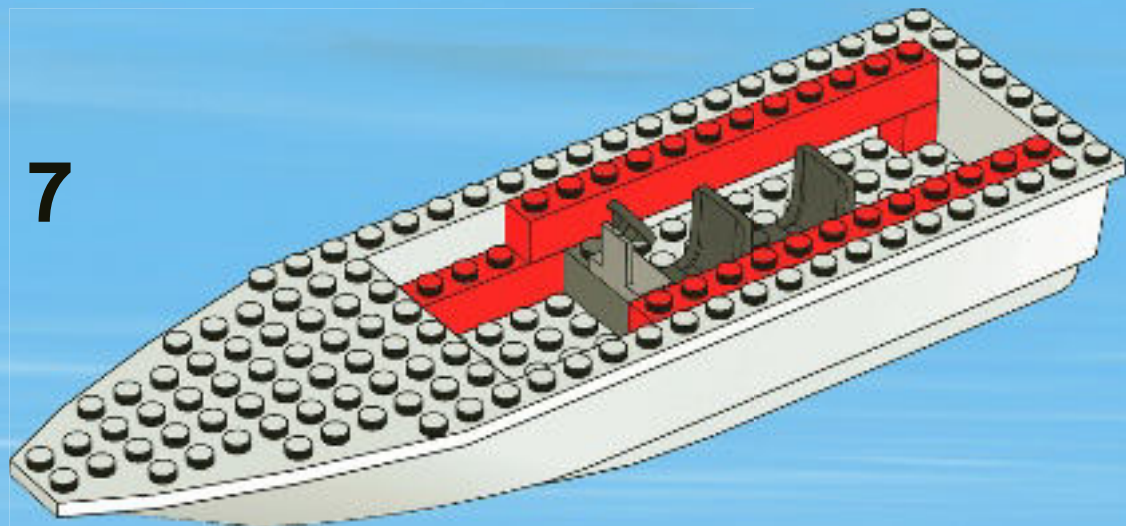

8

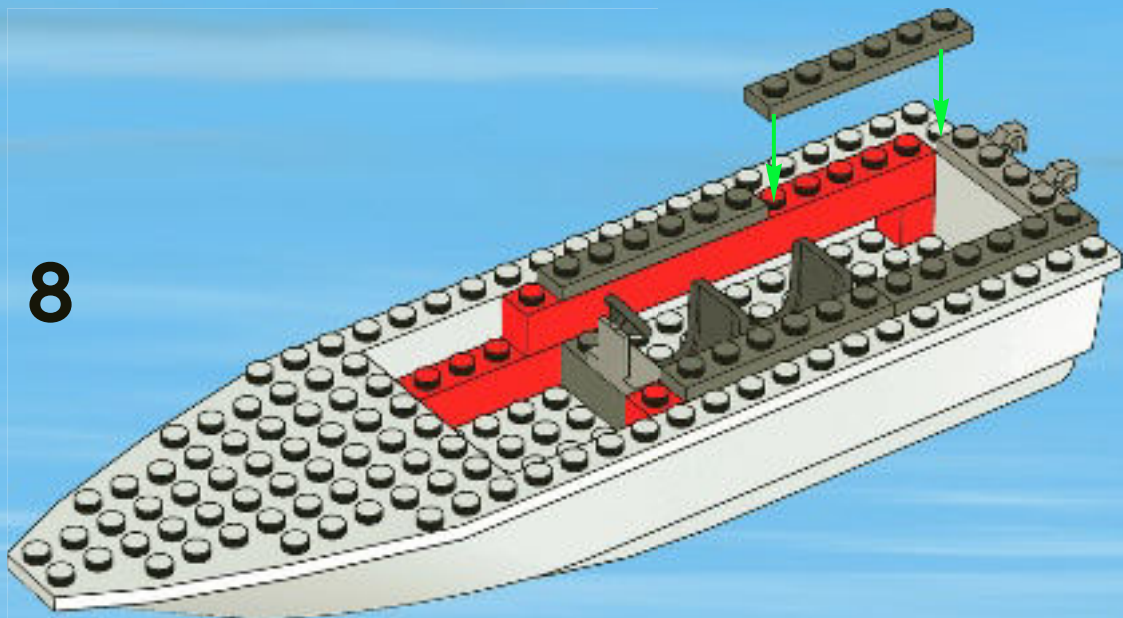

9

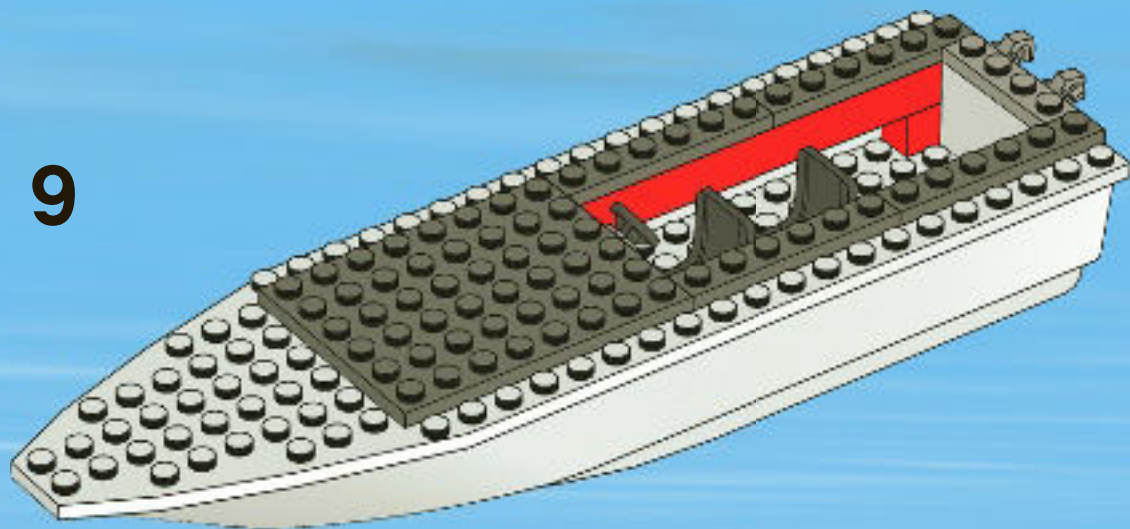

10

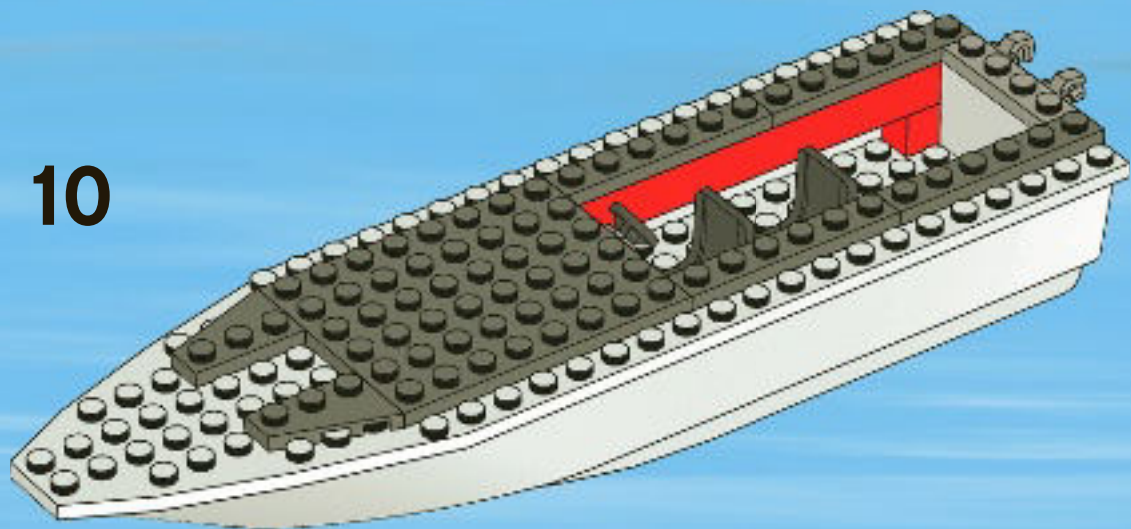

11

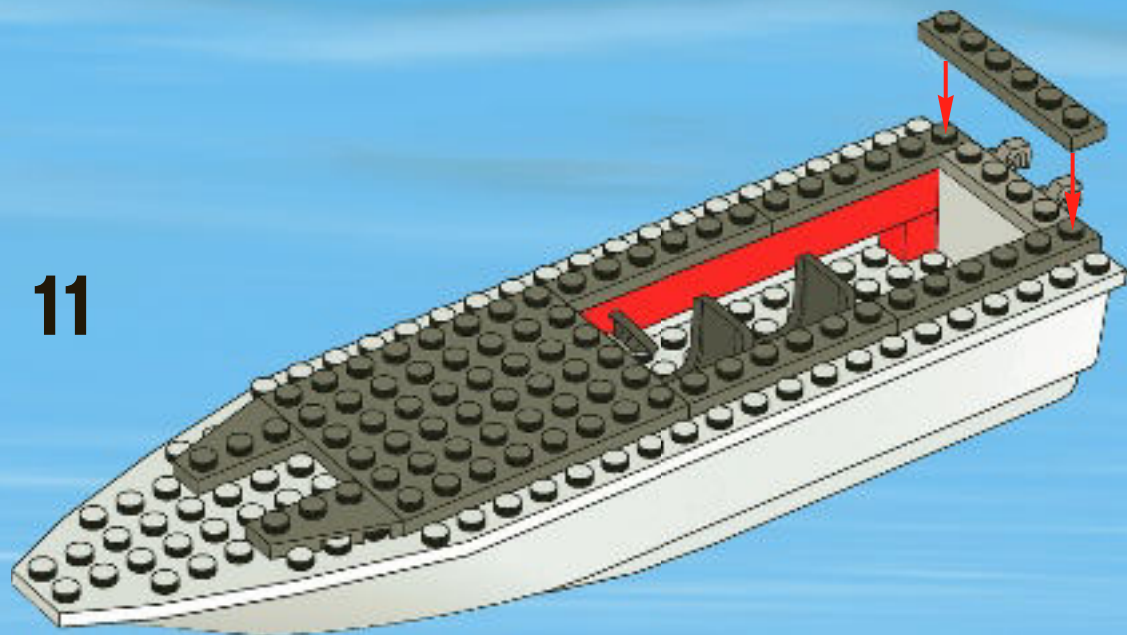

12

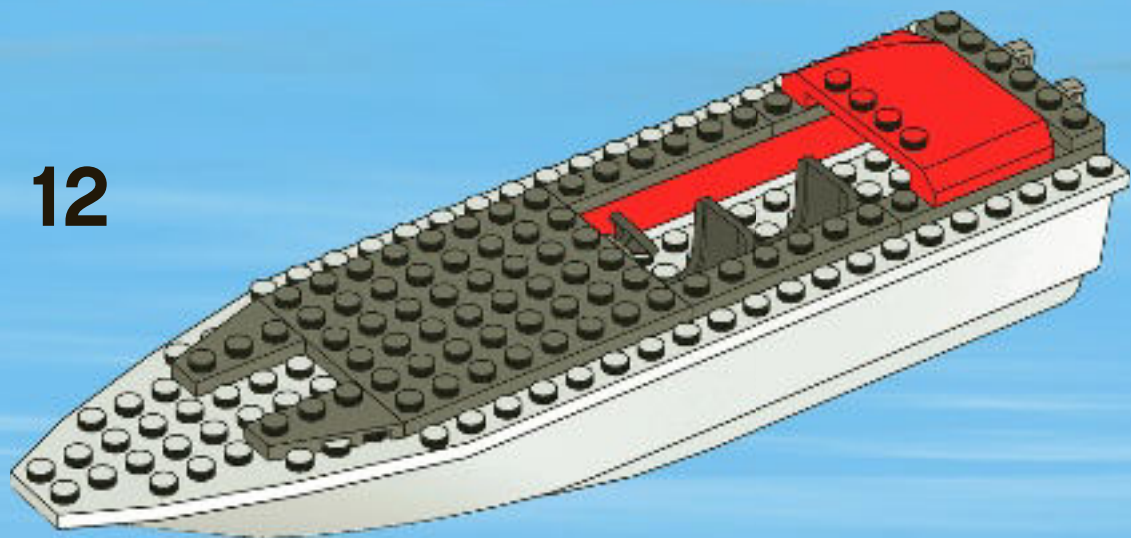

13

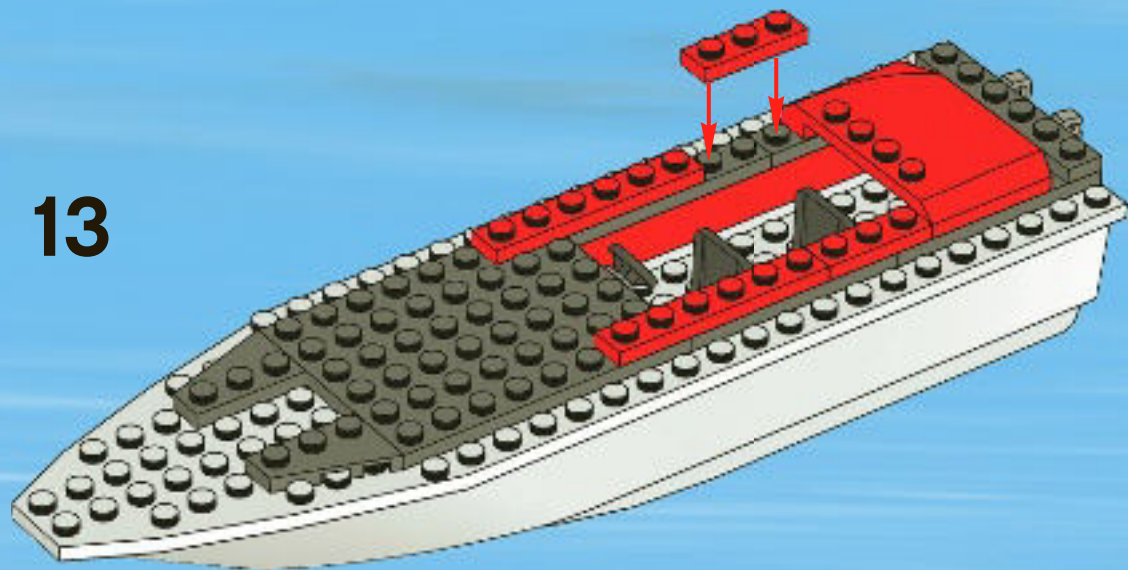

14

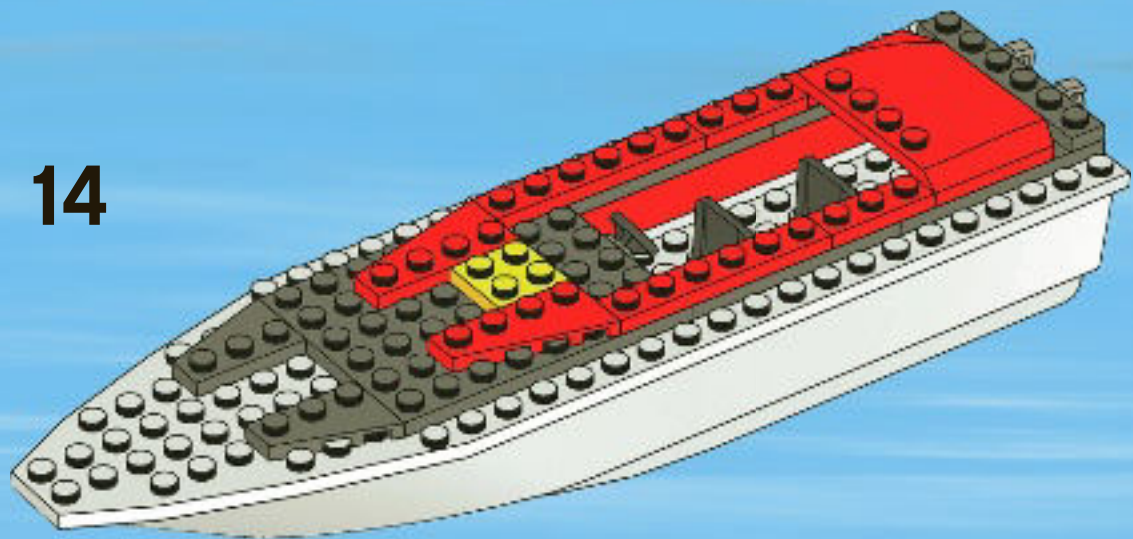

15

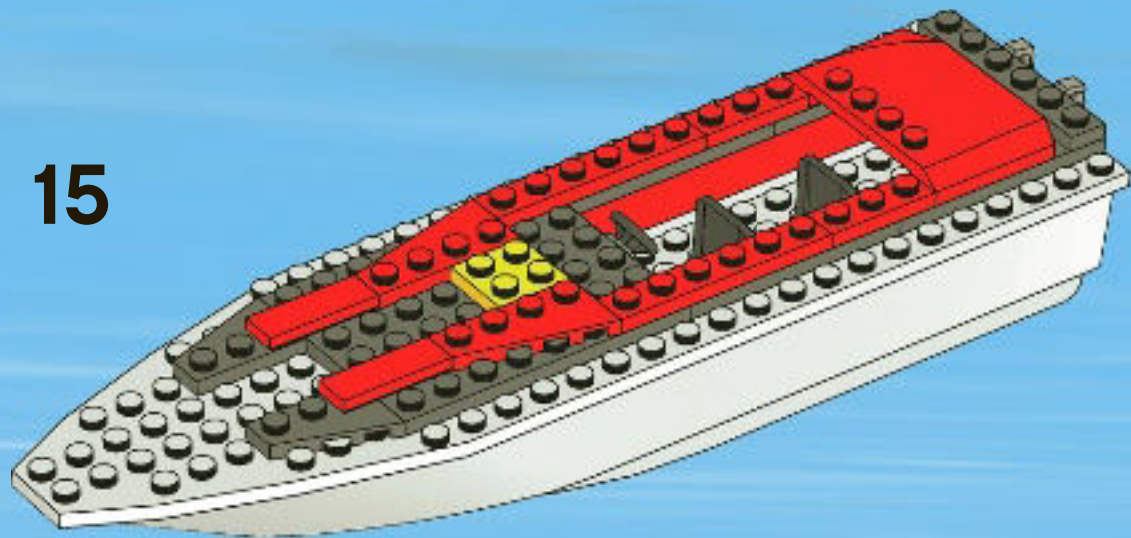

16

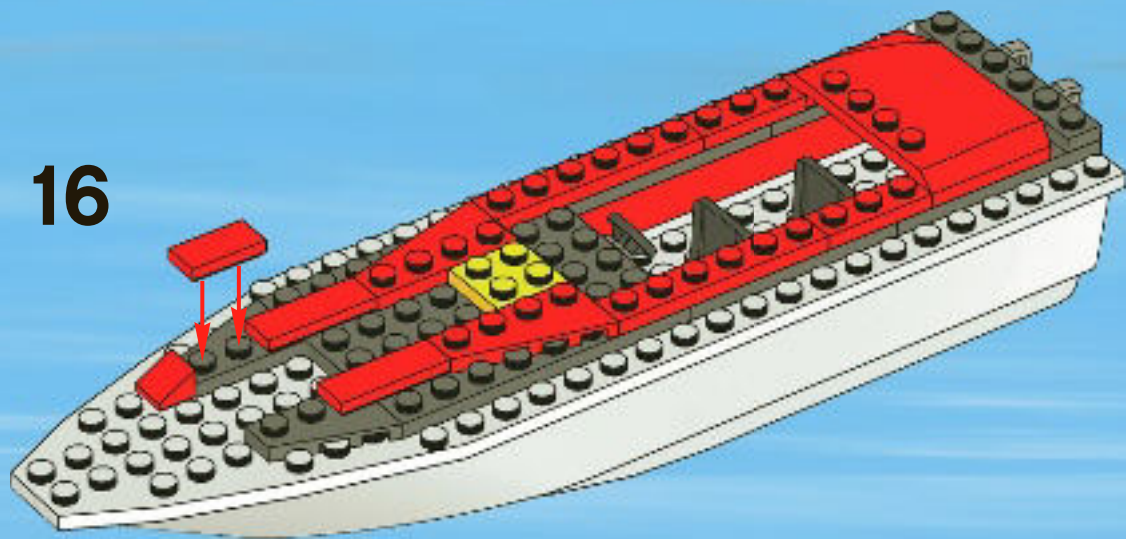

17

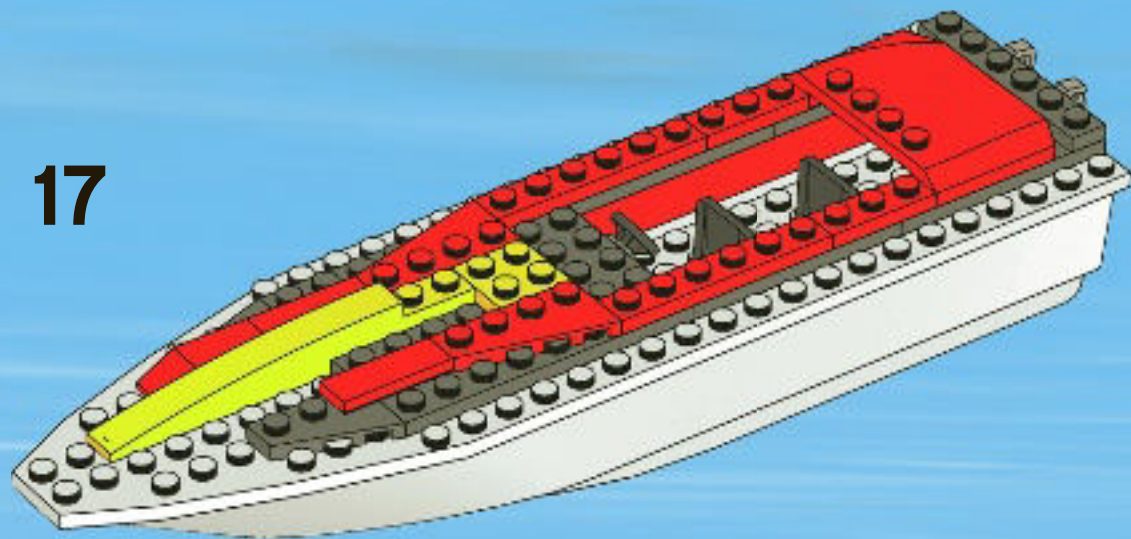

18

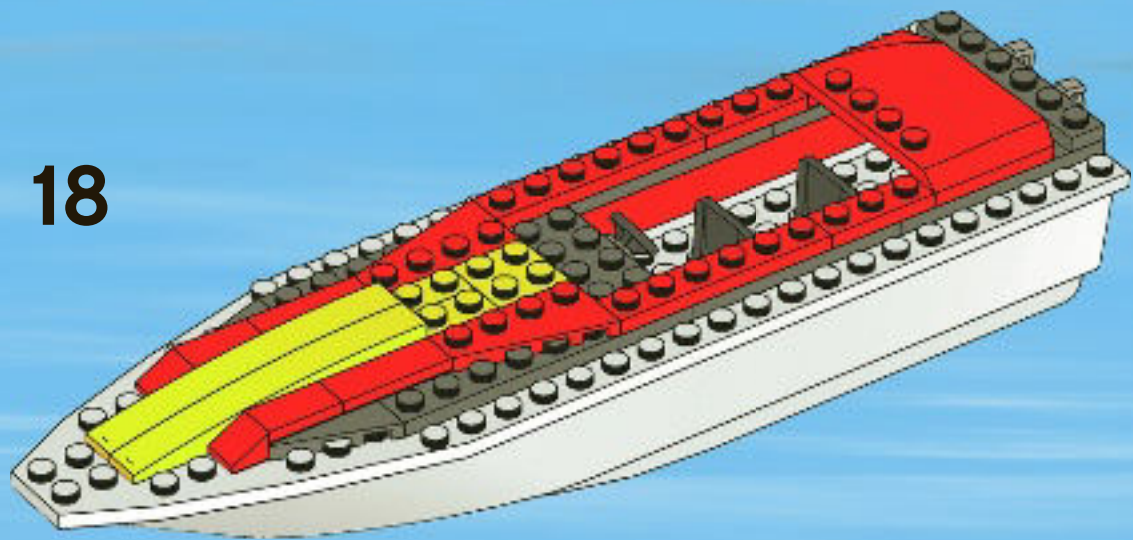

19

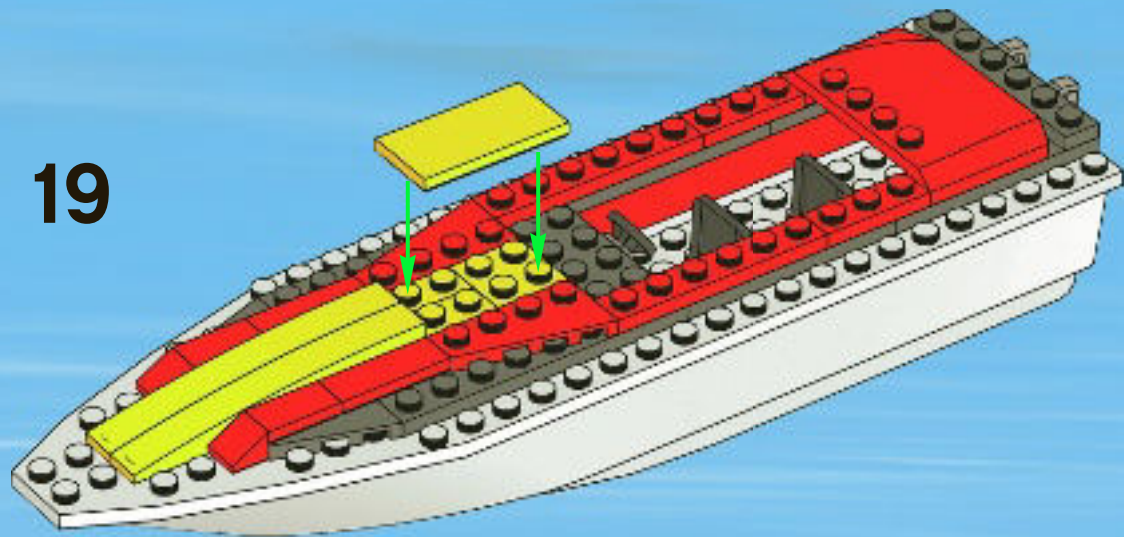



1



2

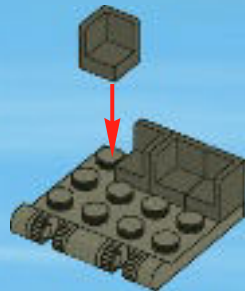

3

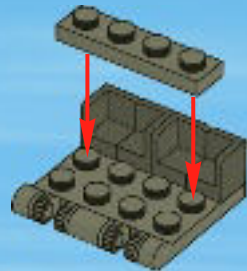

4

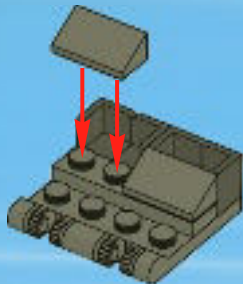

5



6

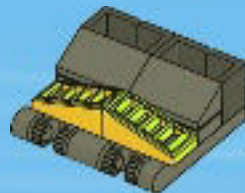

20

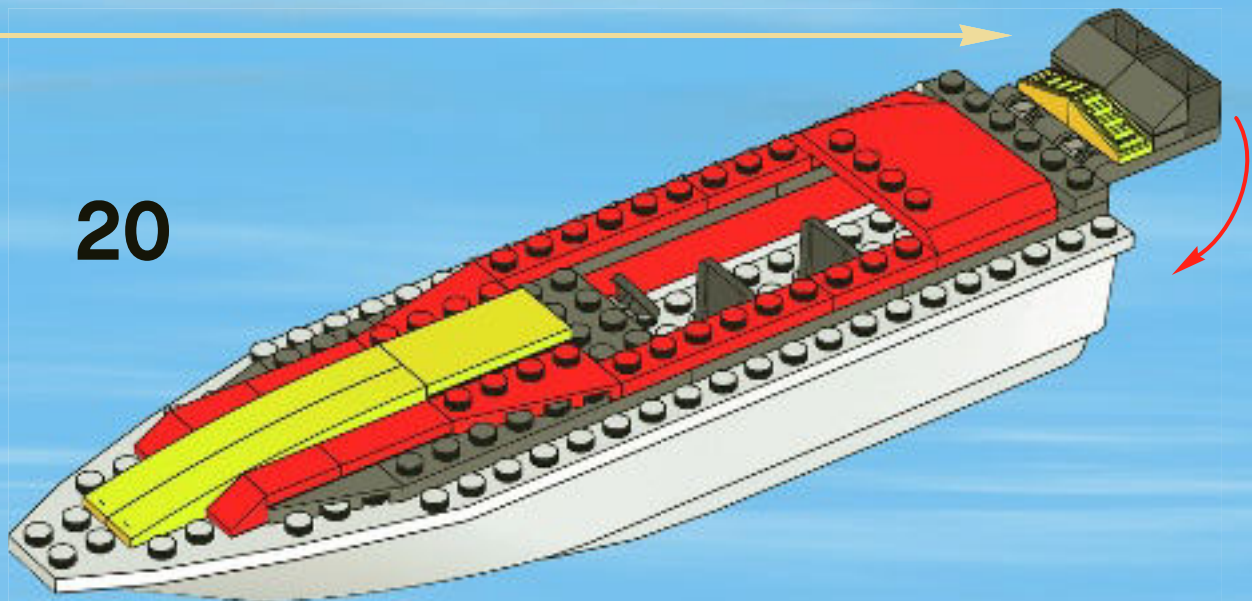

21

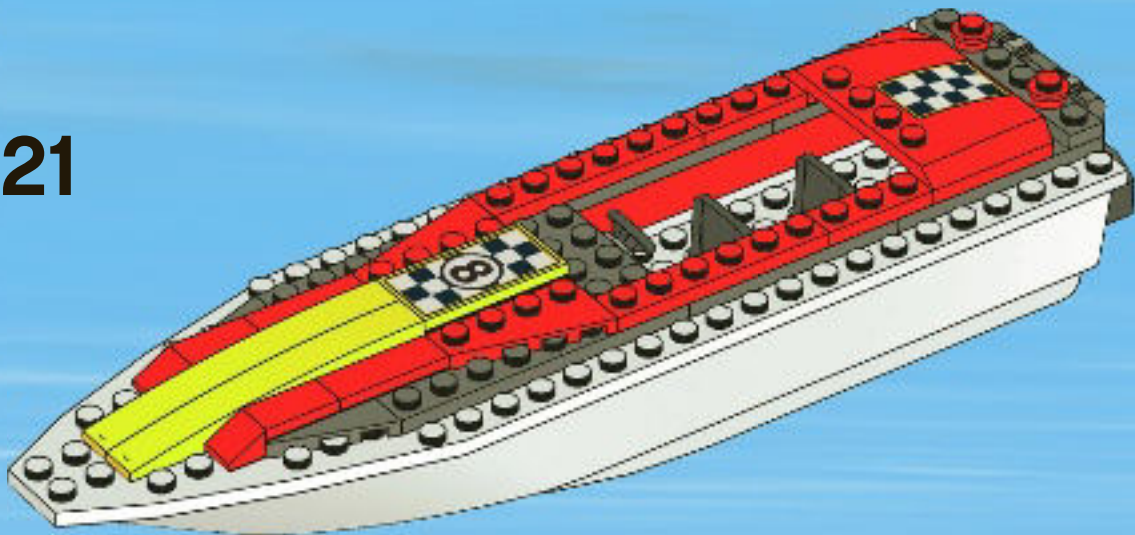

22

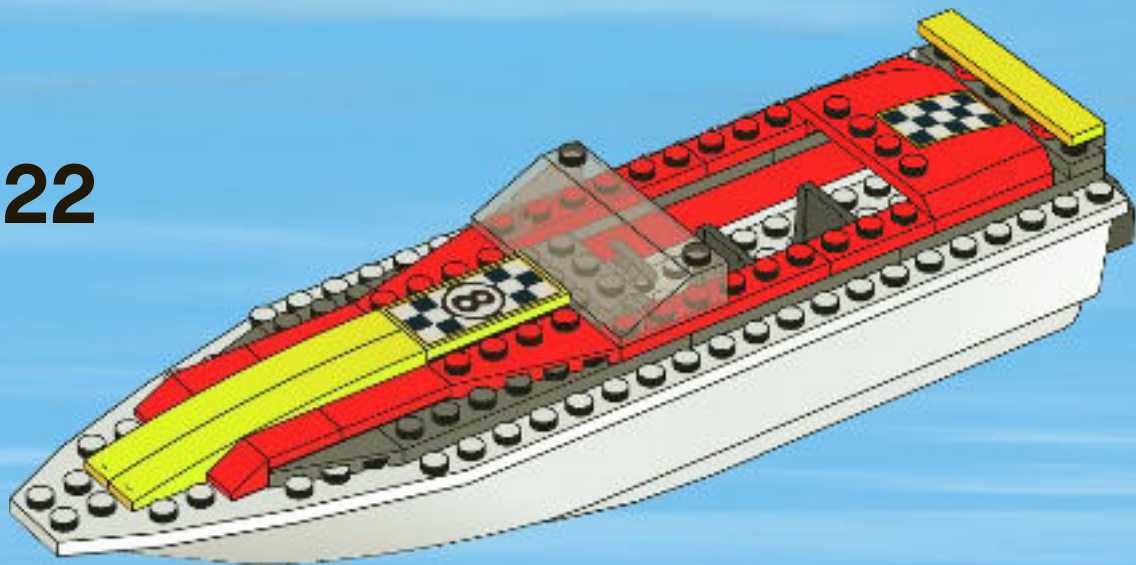

23

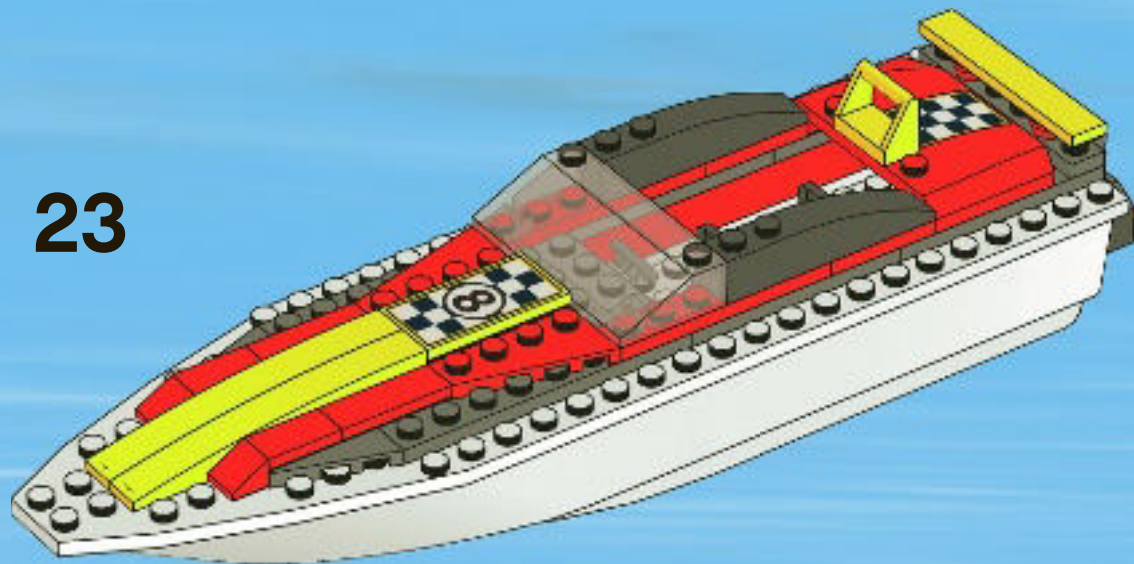

24

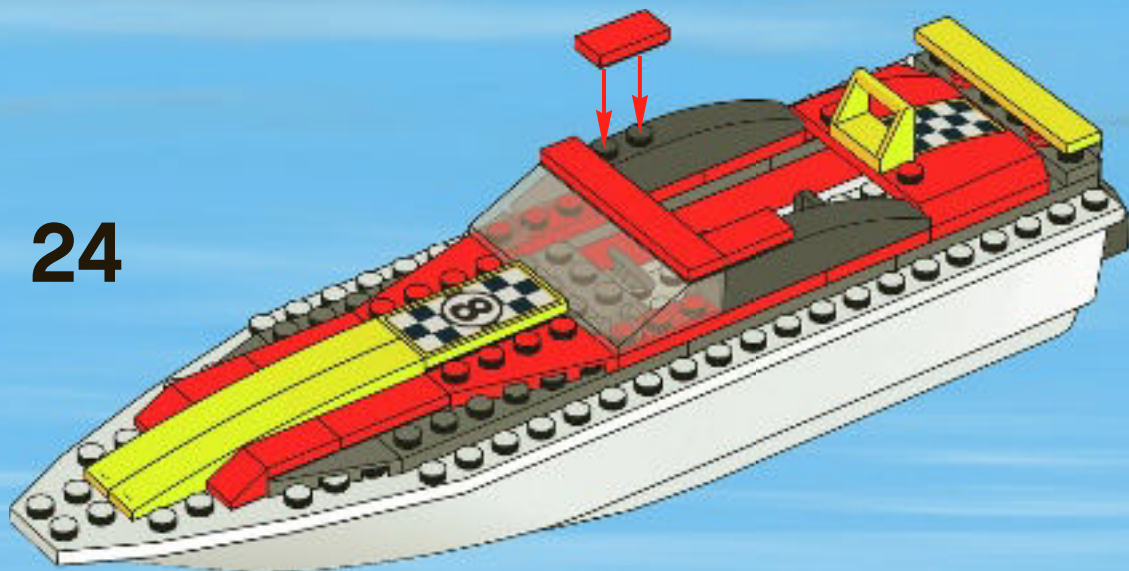



25

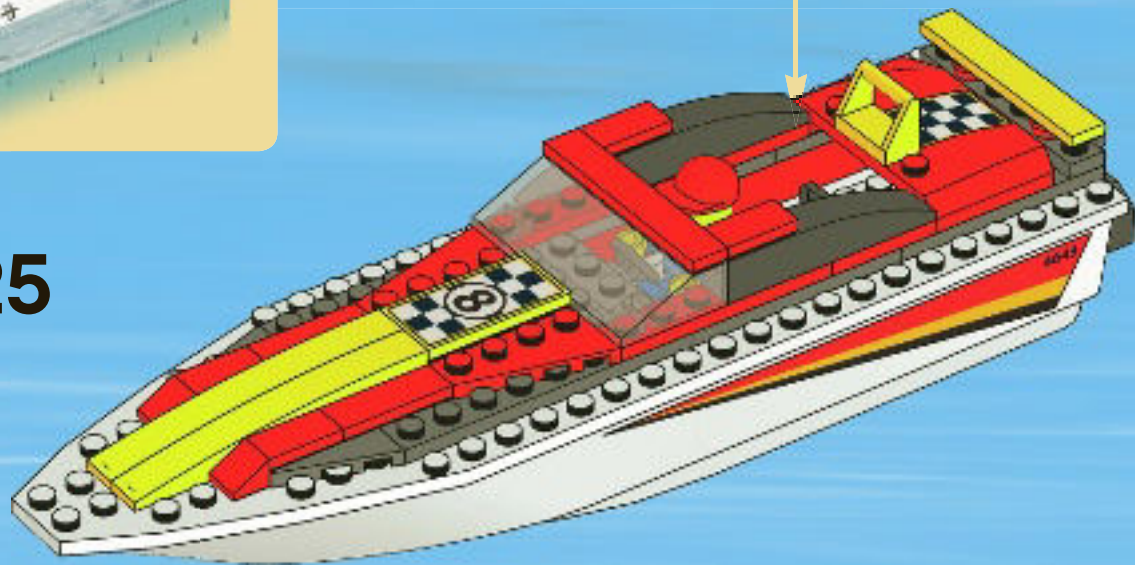

LEGO

CITY



7279



7285



7286



7287



7288



7498



www.LEGOclub.com



LEGO® Club Email



LEGO® Club Magazine

 www.LEGO.com

SIGN UP ONLINE!

www.LEGOclub.com

LEGO and the LEGO logo are trademarks of the LEGO Group. © 2011 The LEGO Group.4631453



00800 5346 5555*



1-866-534-6258 • 1-877-518-5346

US & Canada only

Canada seulement

- * Freephone. Mobile charges may apply.
- * Numéro sans frais. Des frais peuvent s'appliquer avec les téléphones cellulaires.
- * Gebührenfrei. Kosten für Anrufe aus Mobilfunknetzen können abweichen.
- * Gratis telefoonnummer vanaf vaste lijn.
- * Det er et gratis nummer, når du ringer fra fasttelefon.
- * Det är gratis, när du ringer från en fast telefon.
- * Numéro sans frais. Des frais peuvent s'appliquer avec les téléphones portables.



CITY

4643





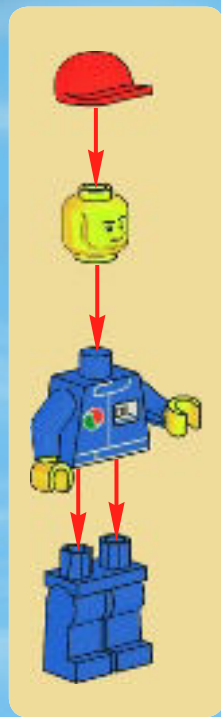

1

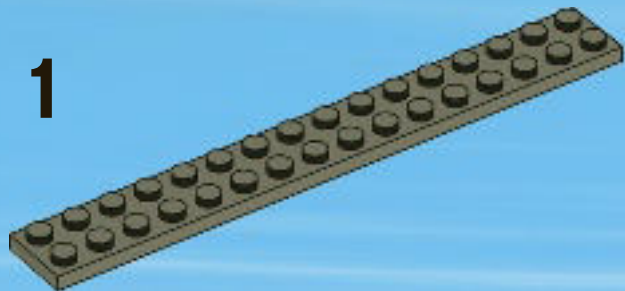

2

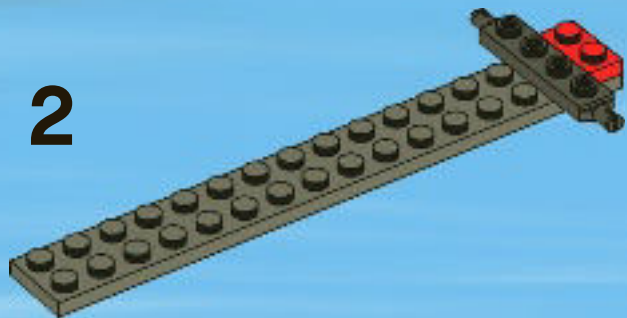

3

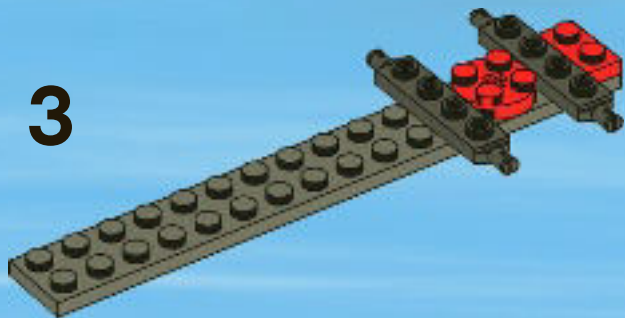

4

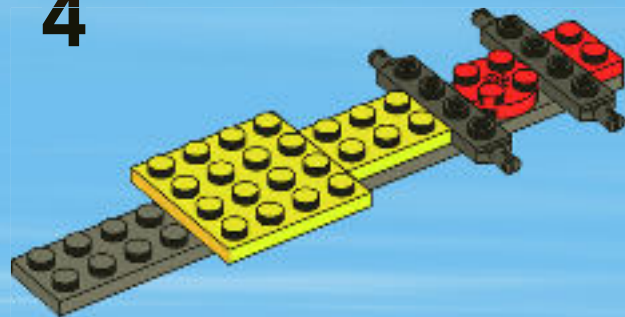

5

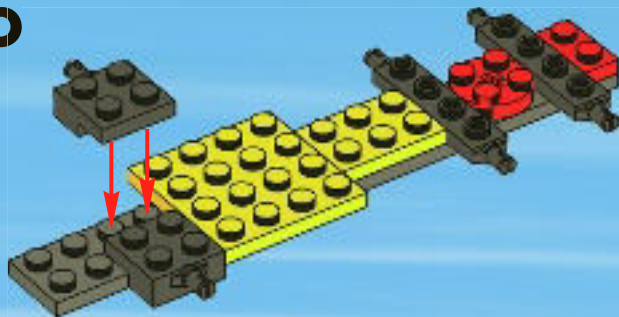

6

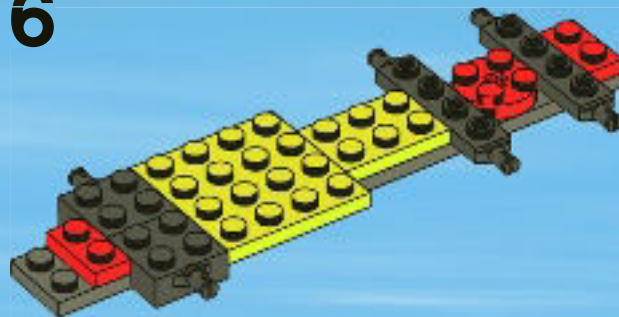

1

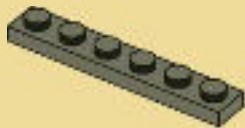

2

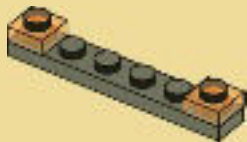

7

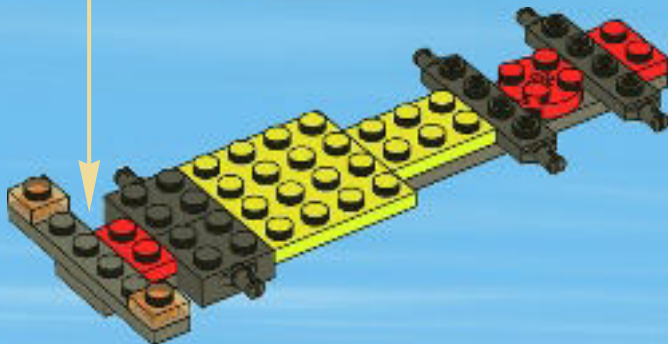

8

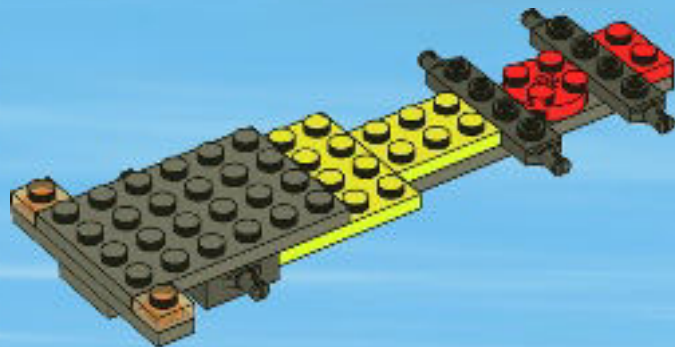

9

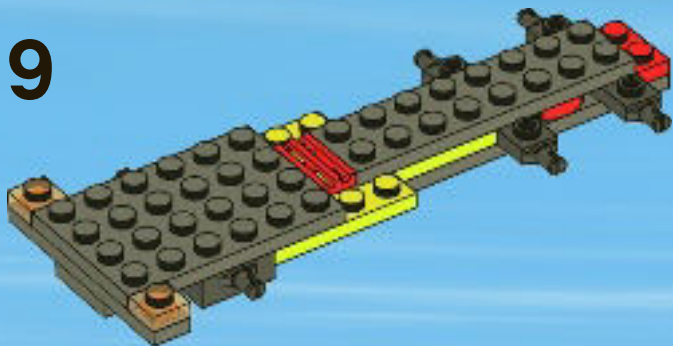

10

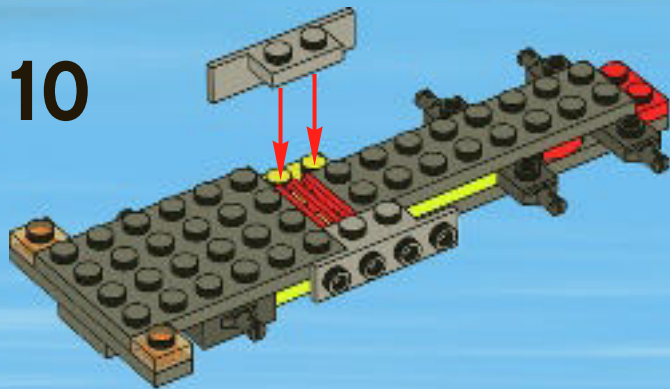

1



2

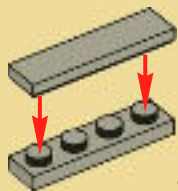

2x

11

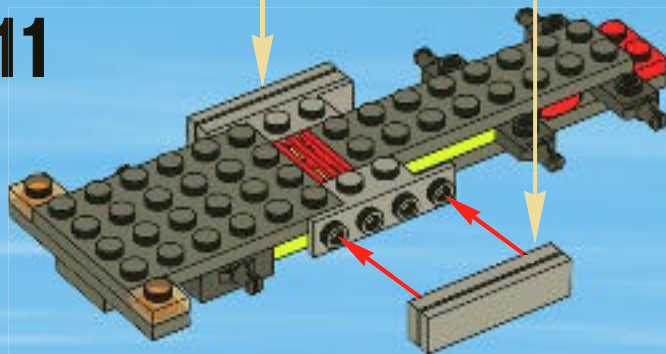

12

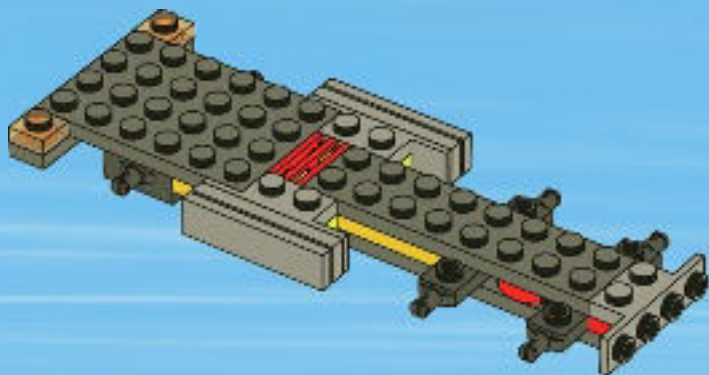

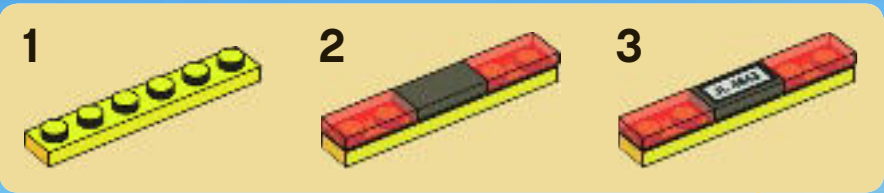

13

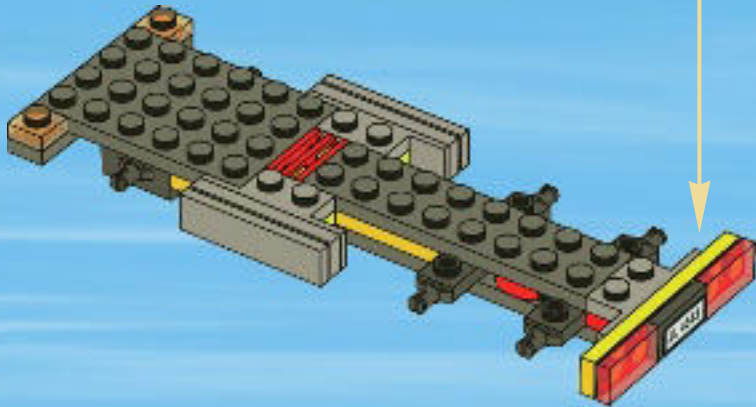

14

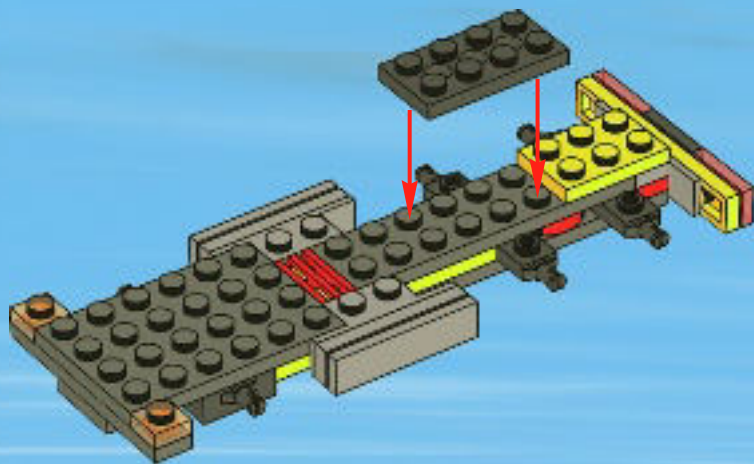

15

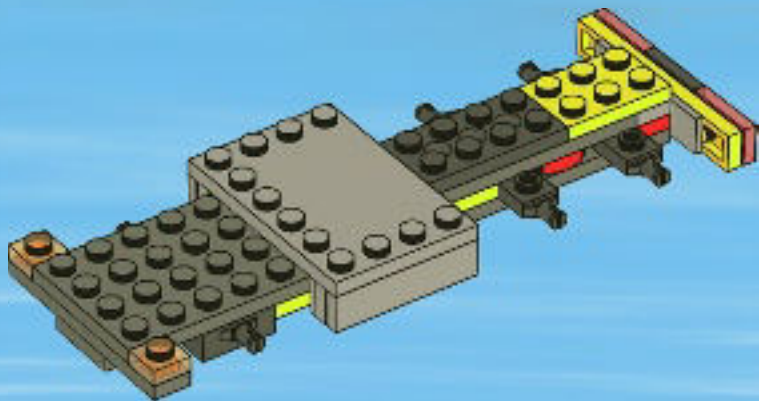

16

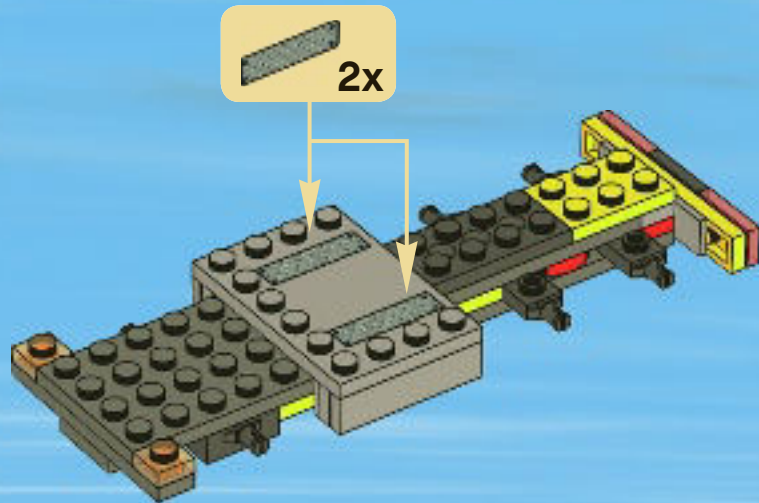

17

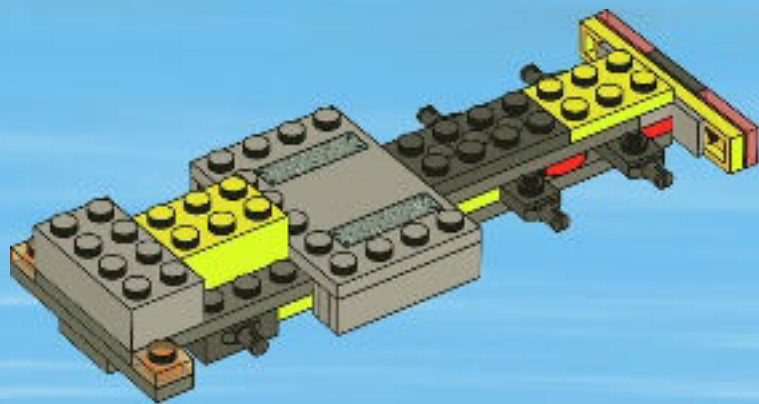

18

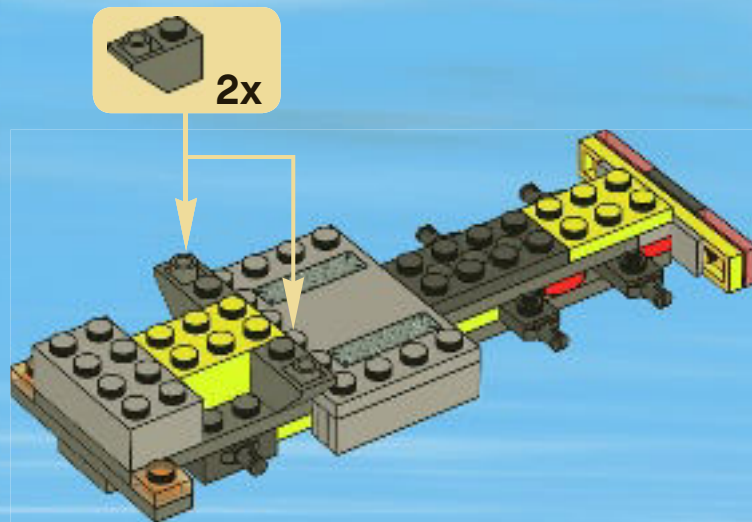

19

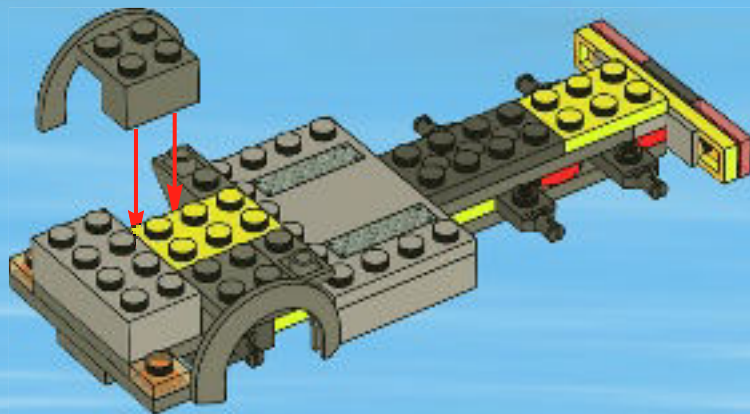

20

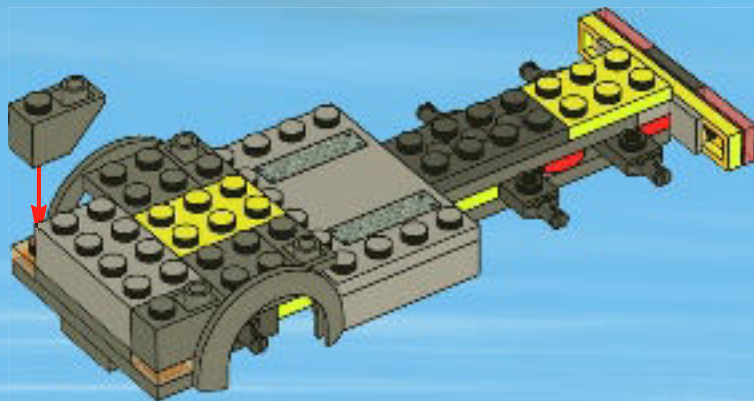

21

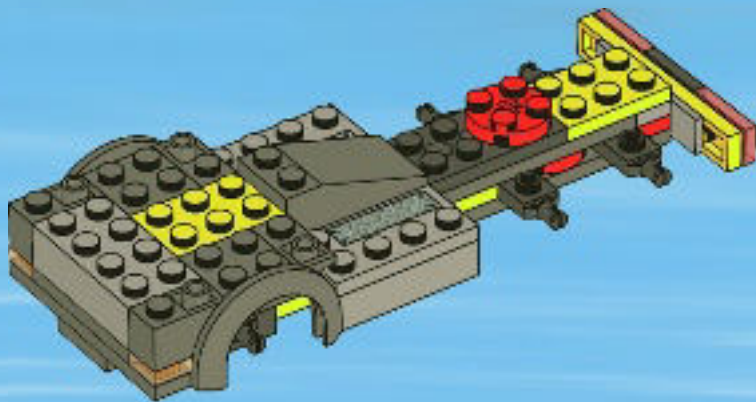

22

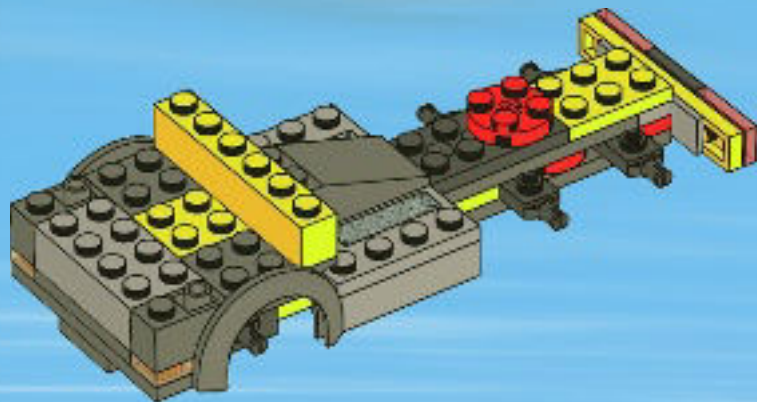

23

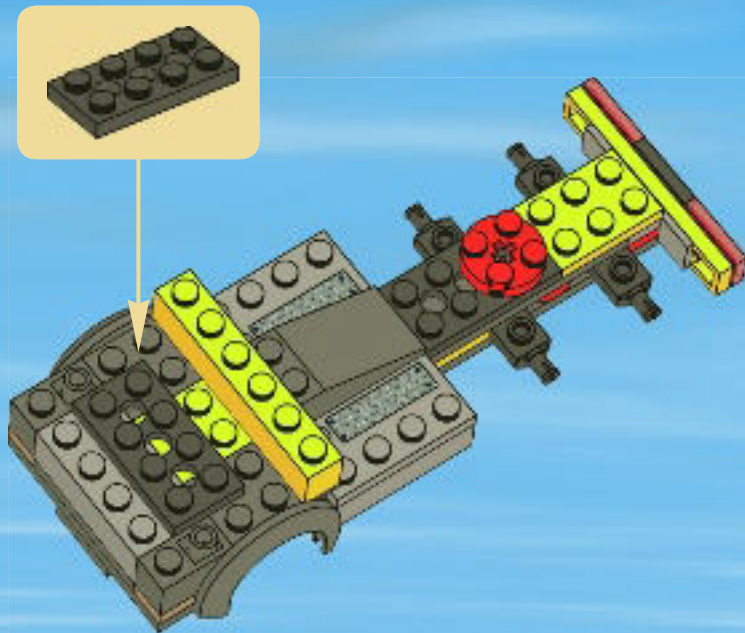

24

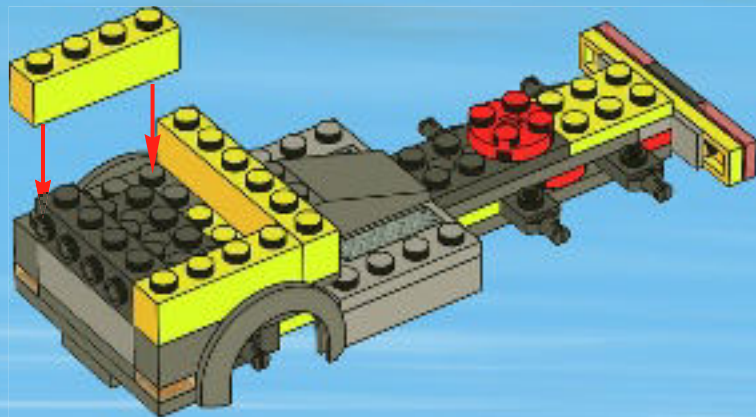

25

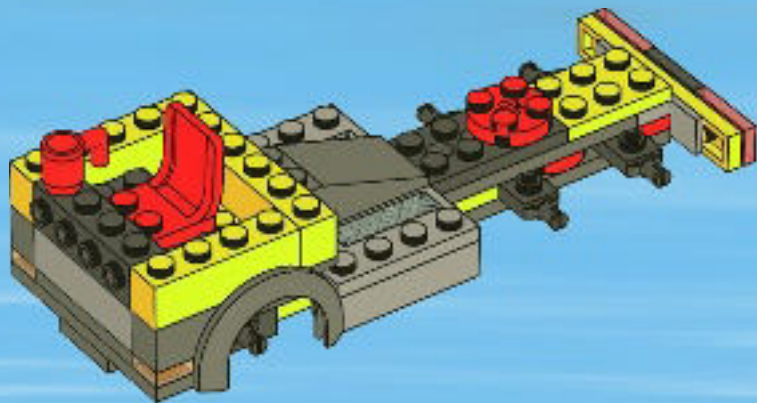

26

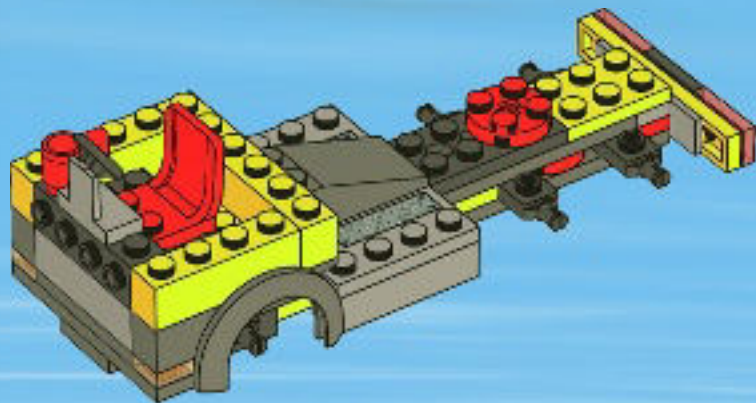



1



2

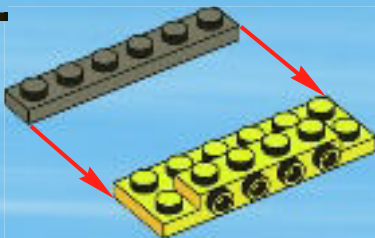

3

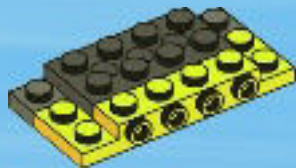

4

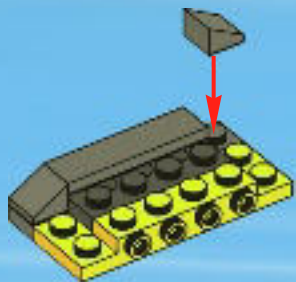

5



6

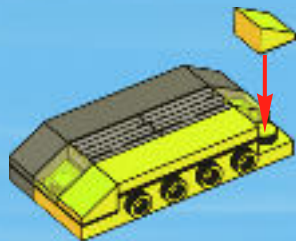

7



27

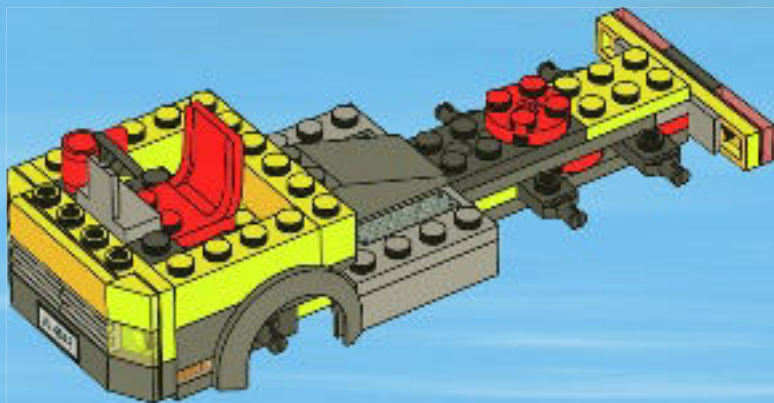

28

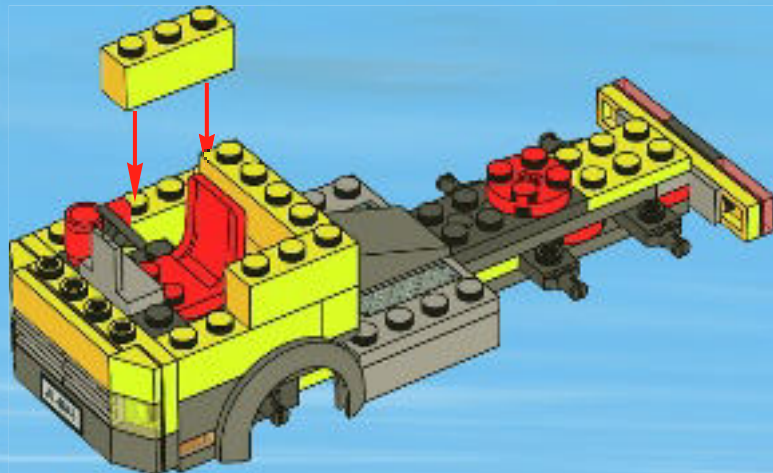

1



2



29

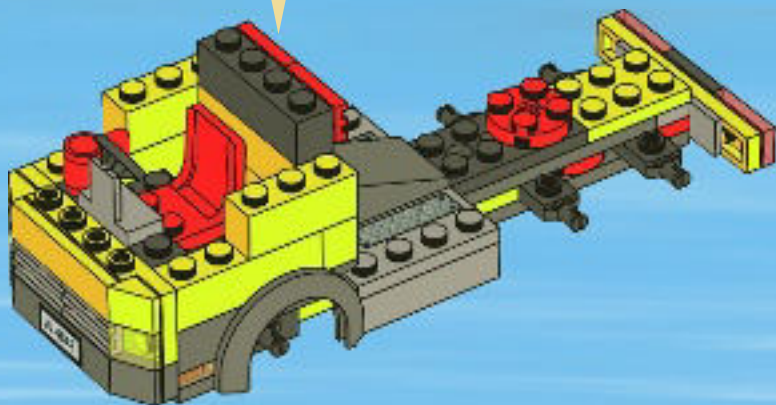

30

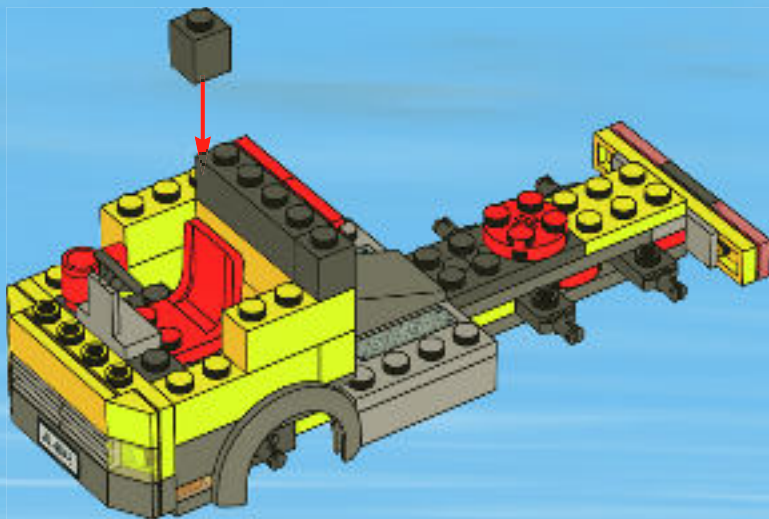

31

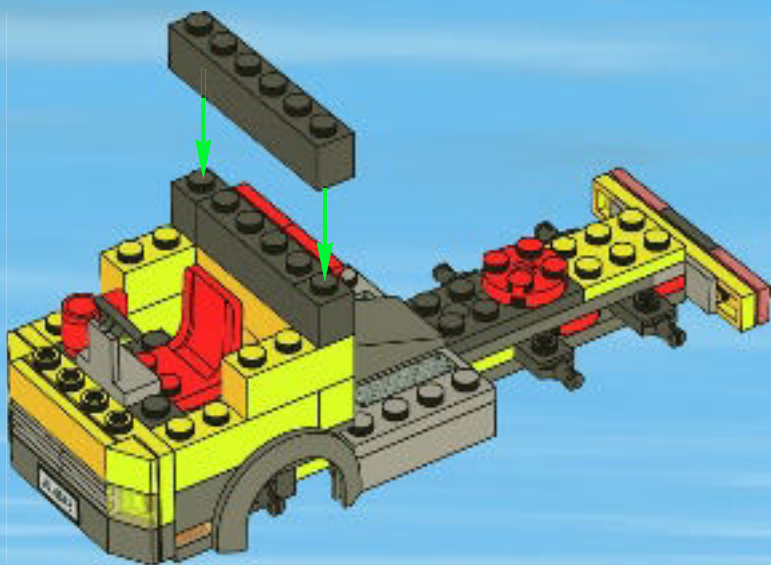

32

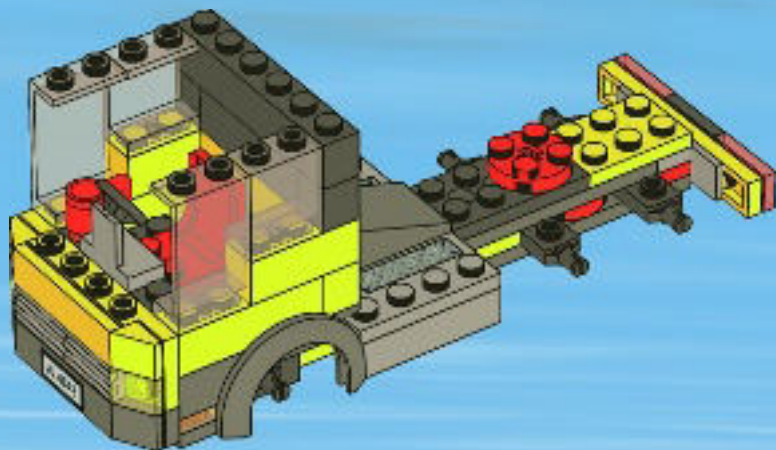

33

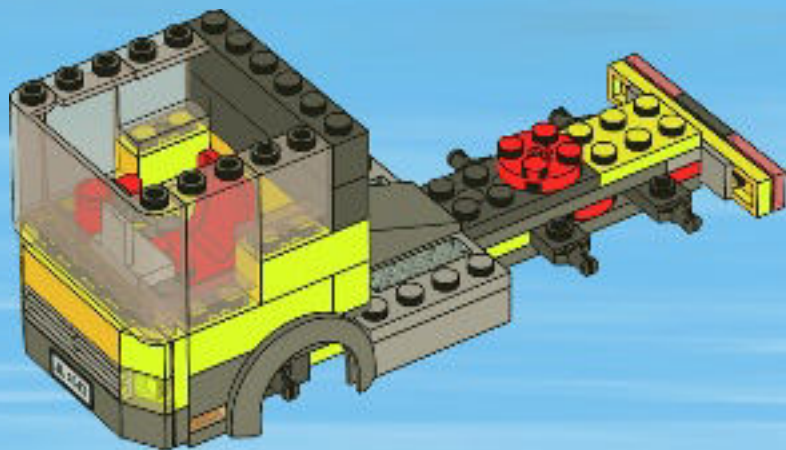

34

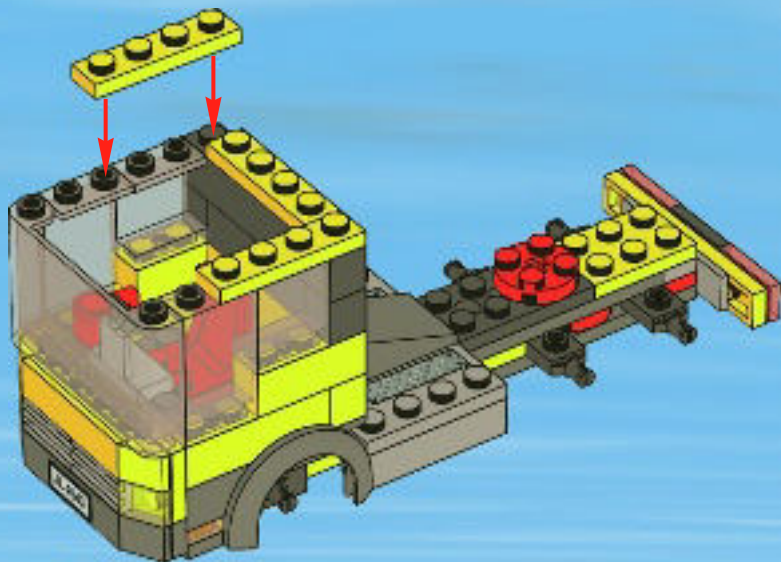

35

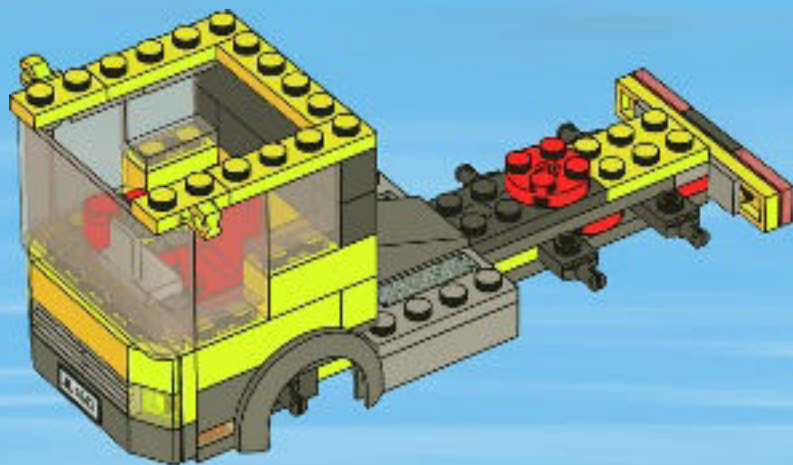

36

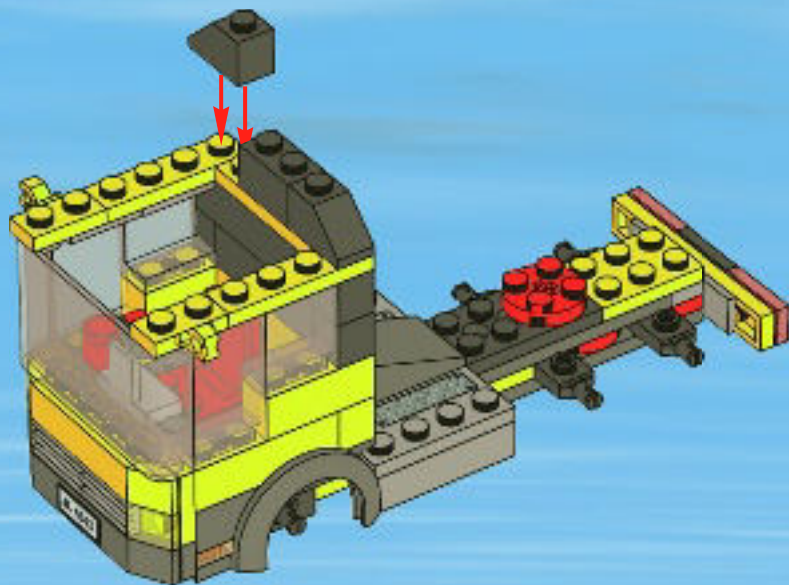

37

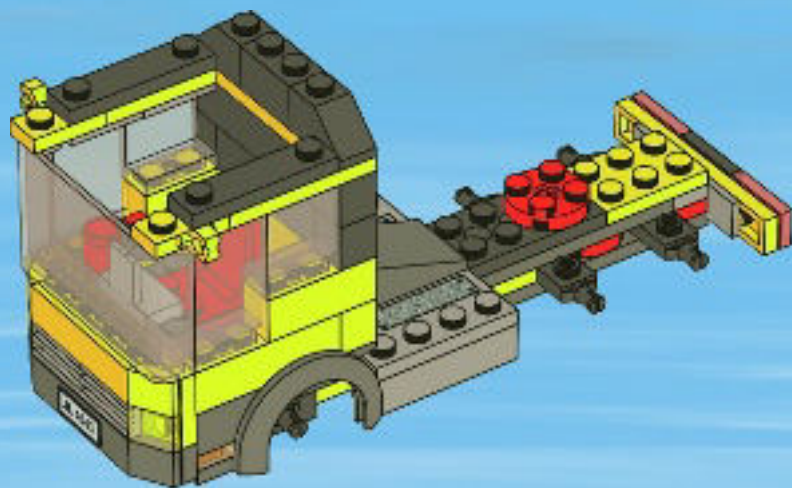

38

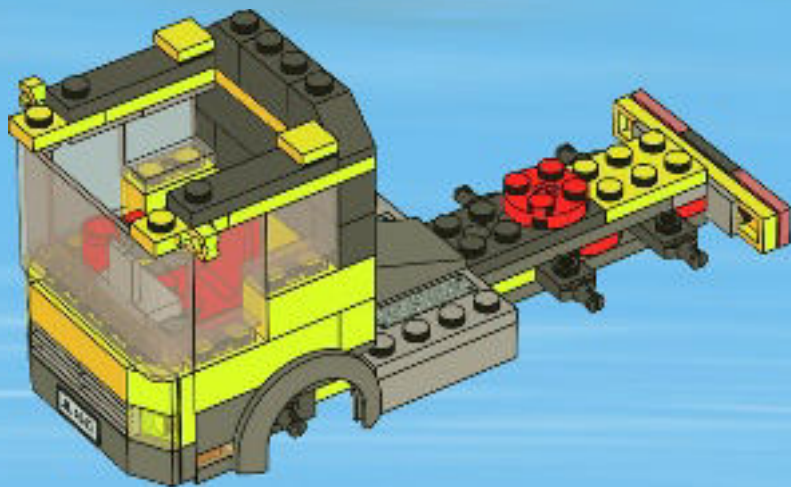

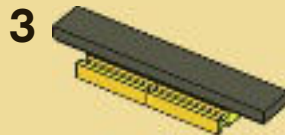
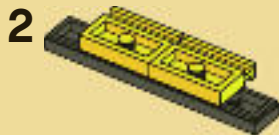

39

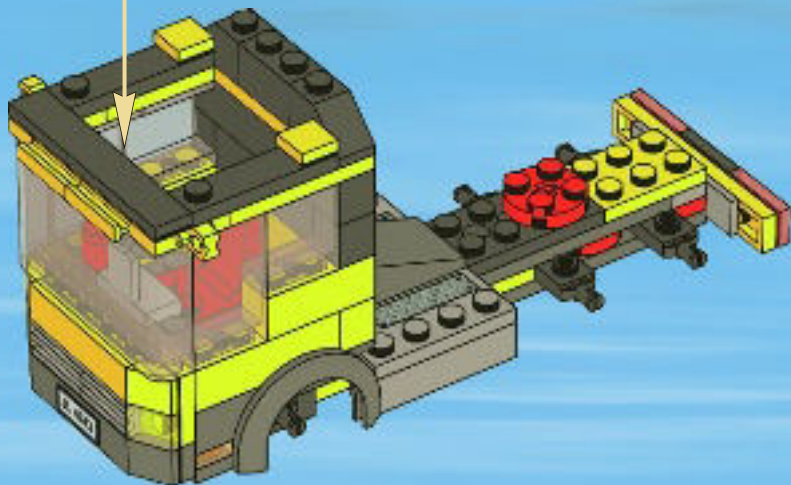

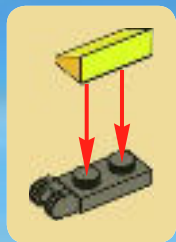

40

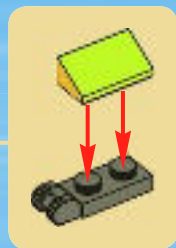
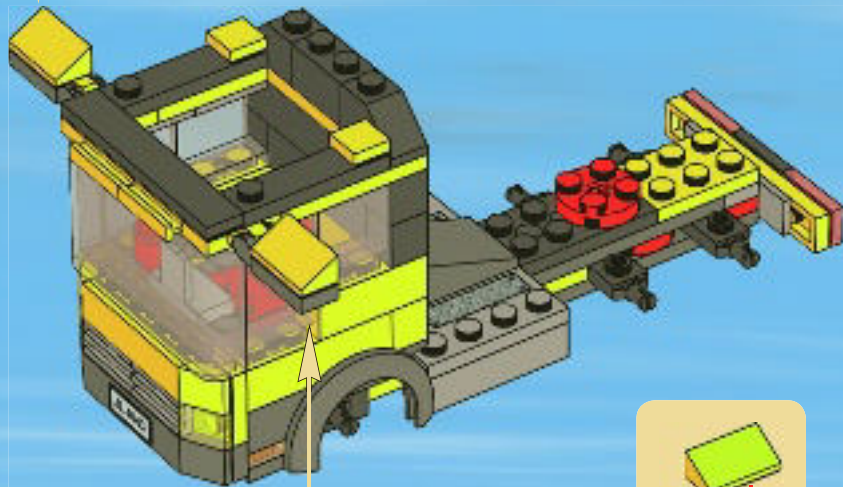



1



2

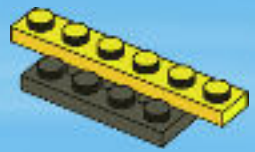

3

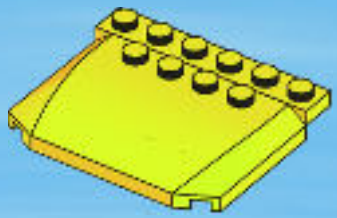

4

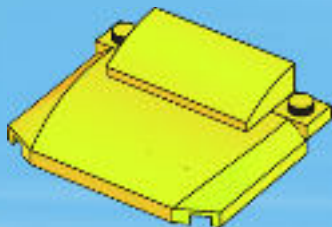

5

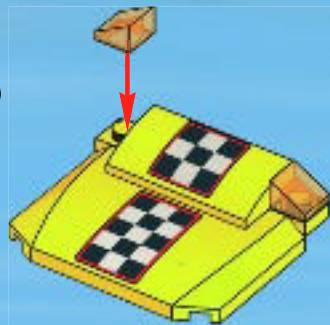

41

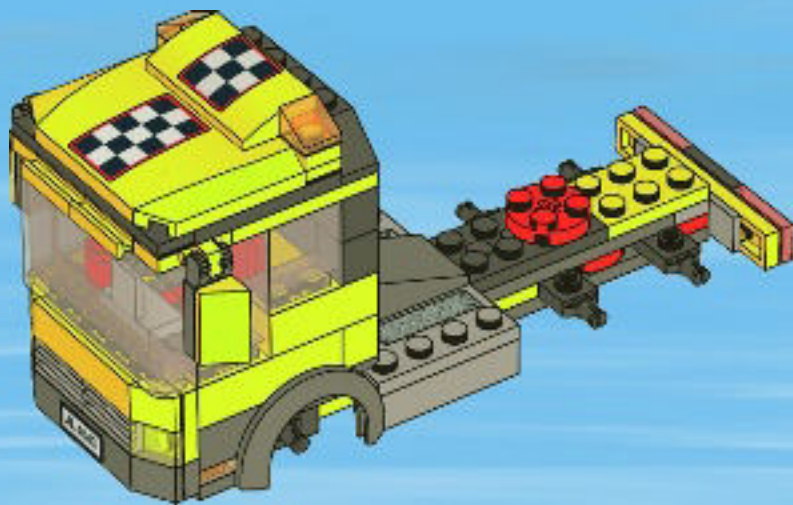

42

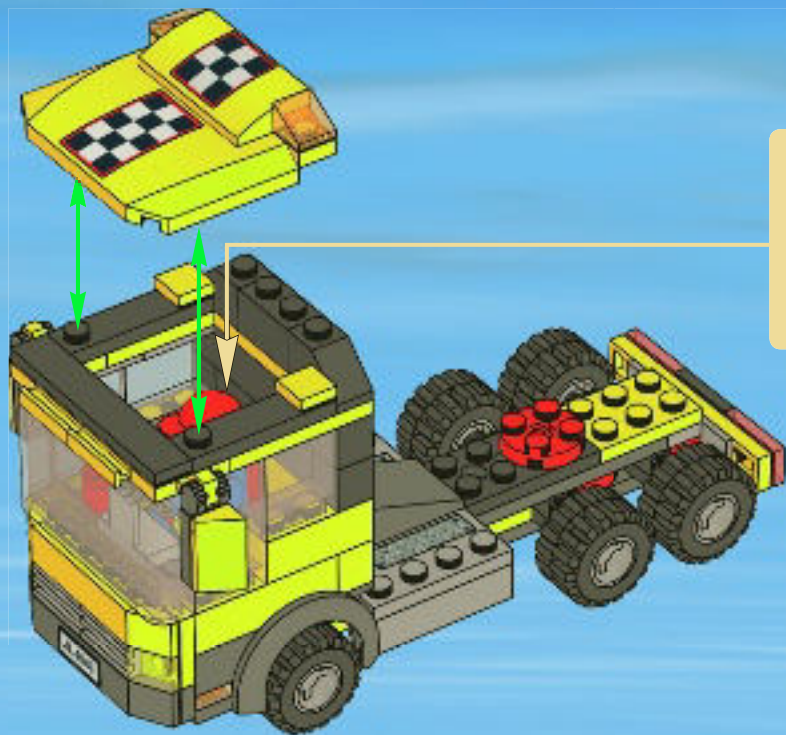

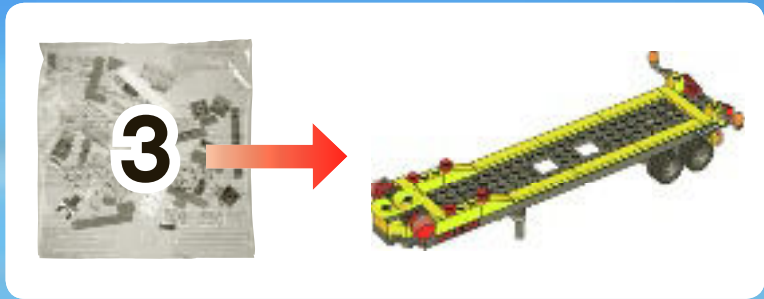

1

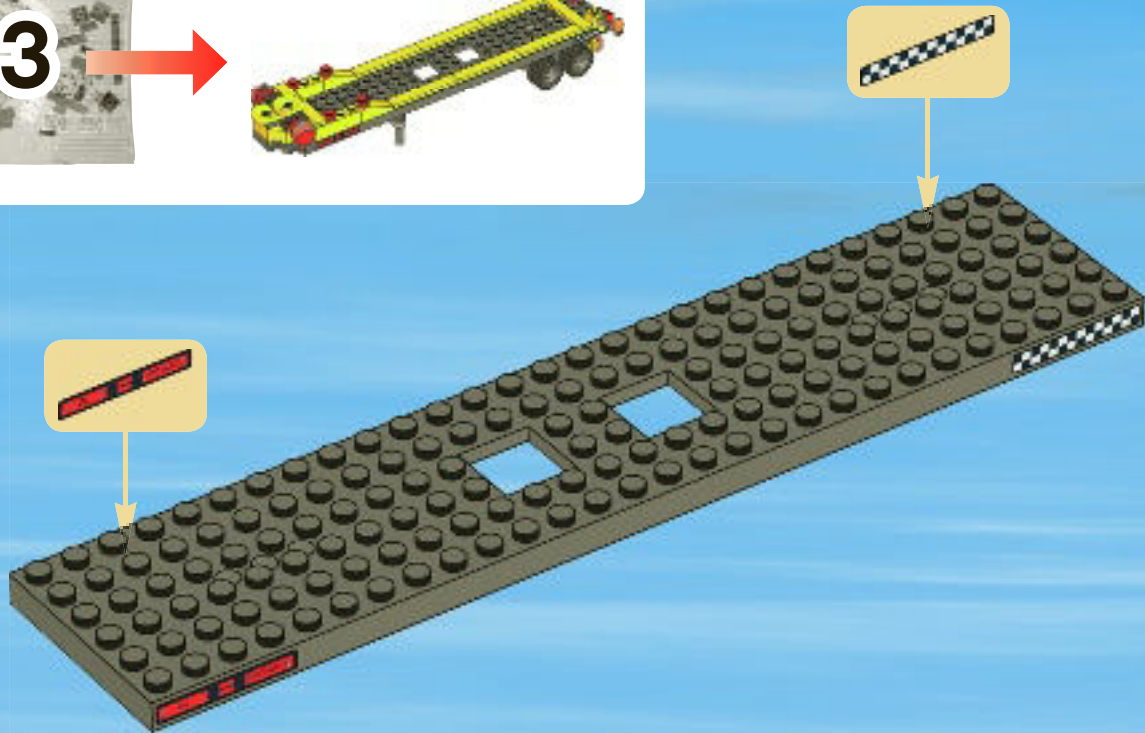

2

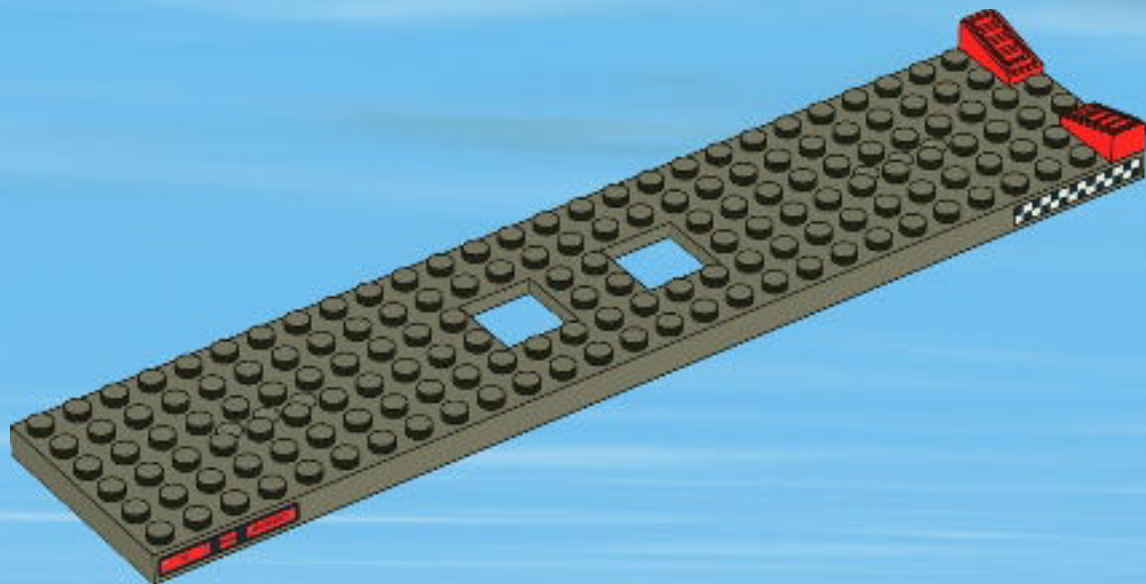

3

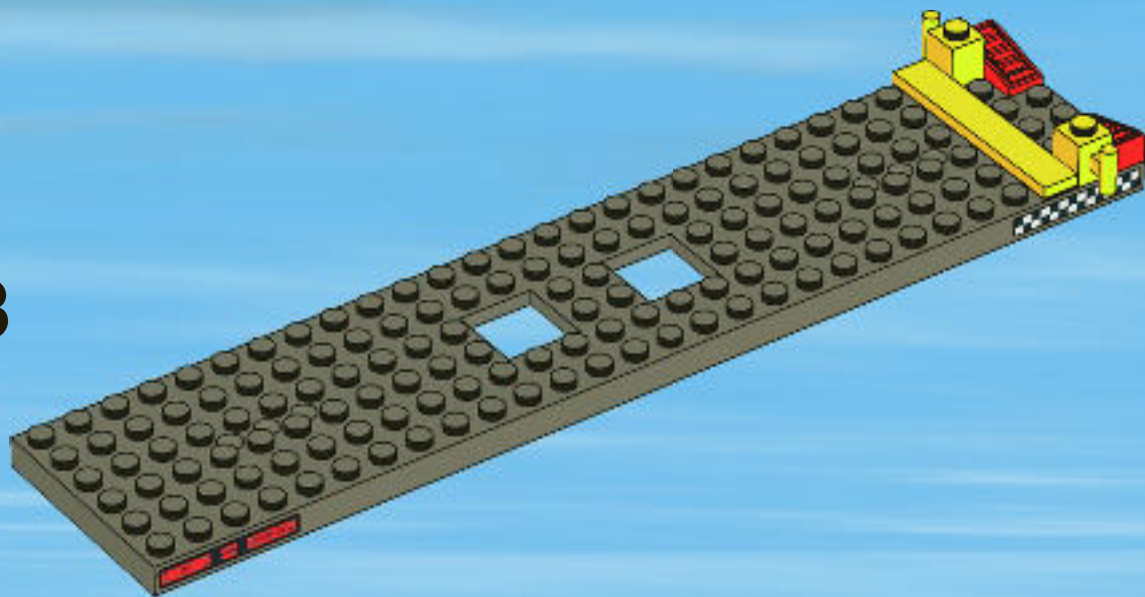

4

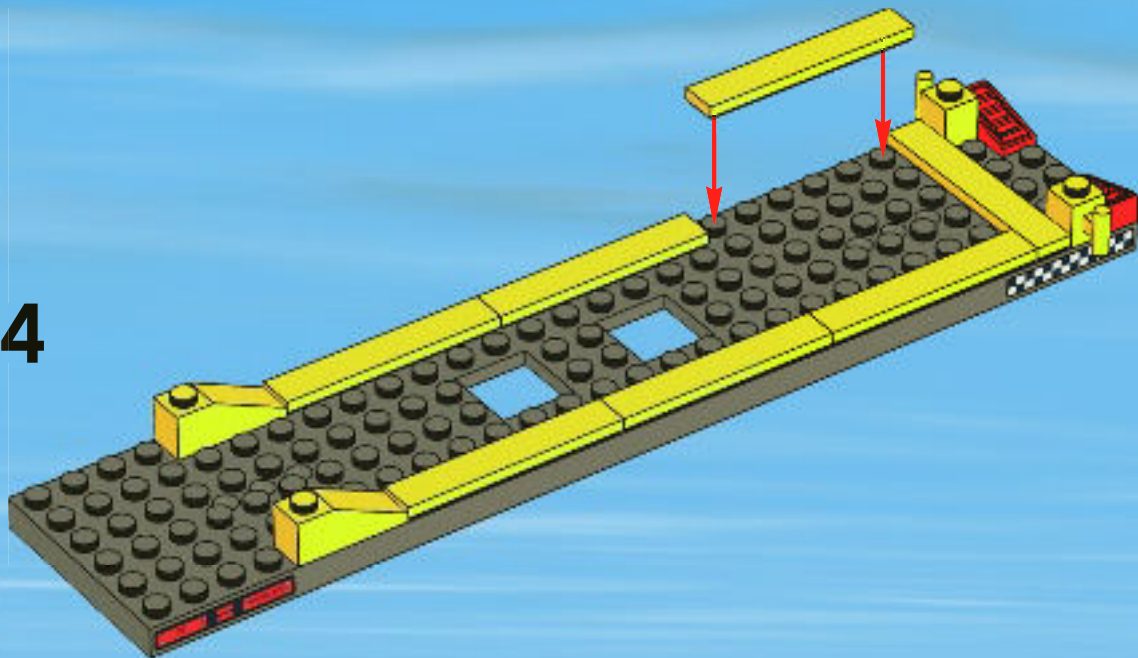

5

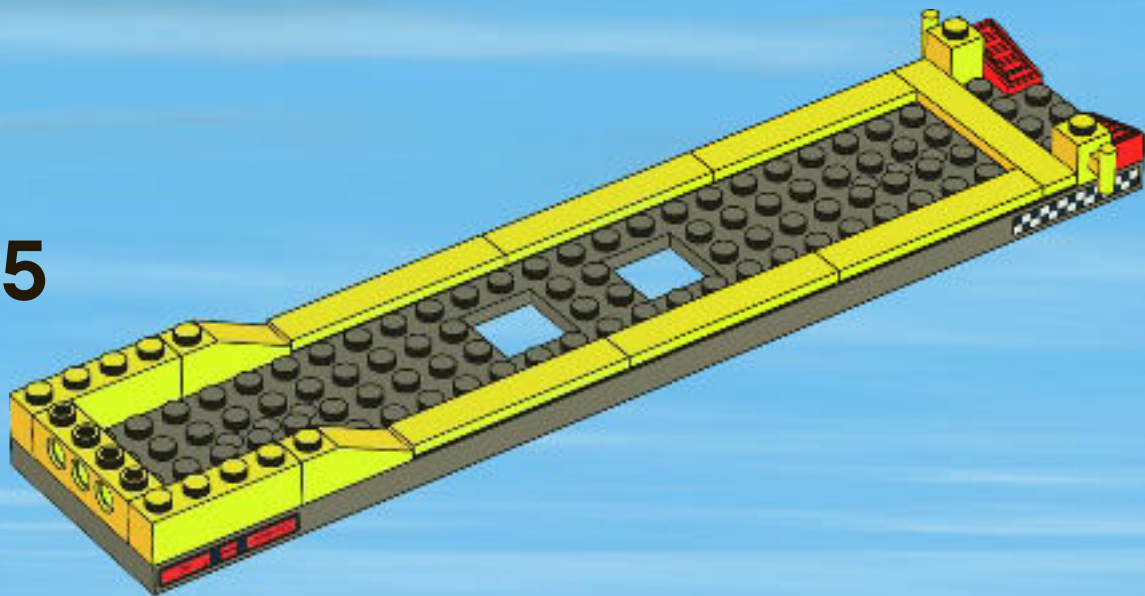

6

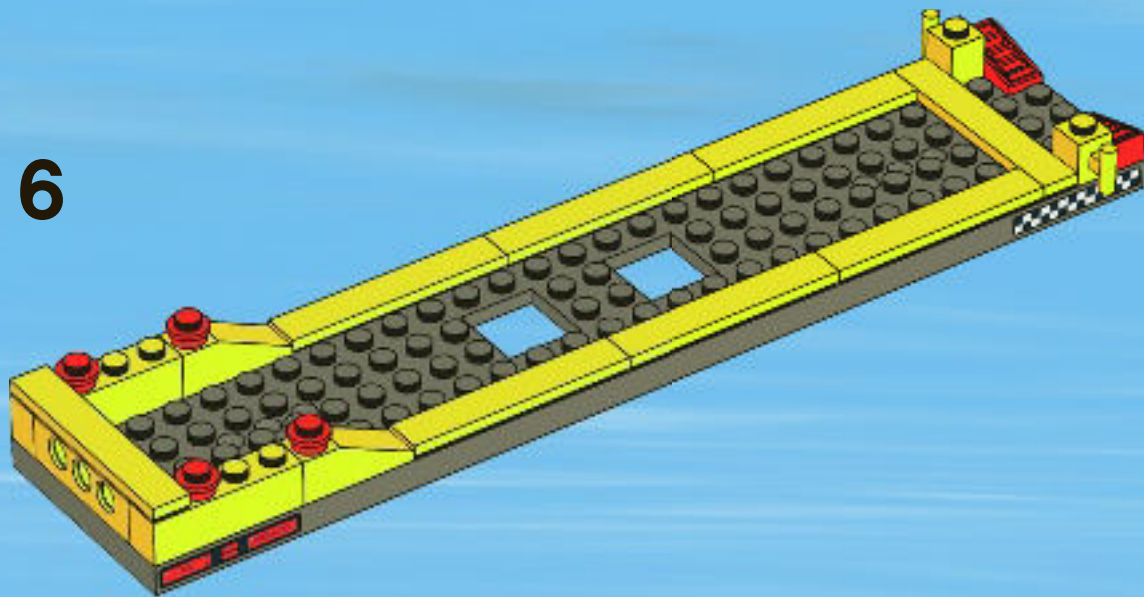

7

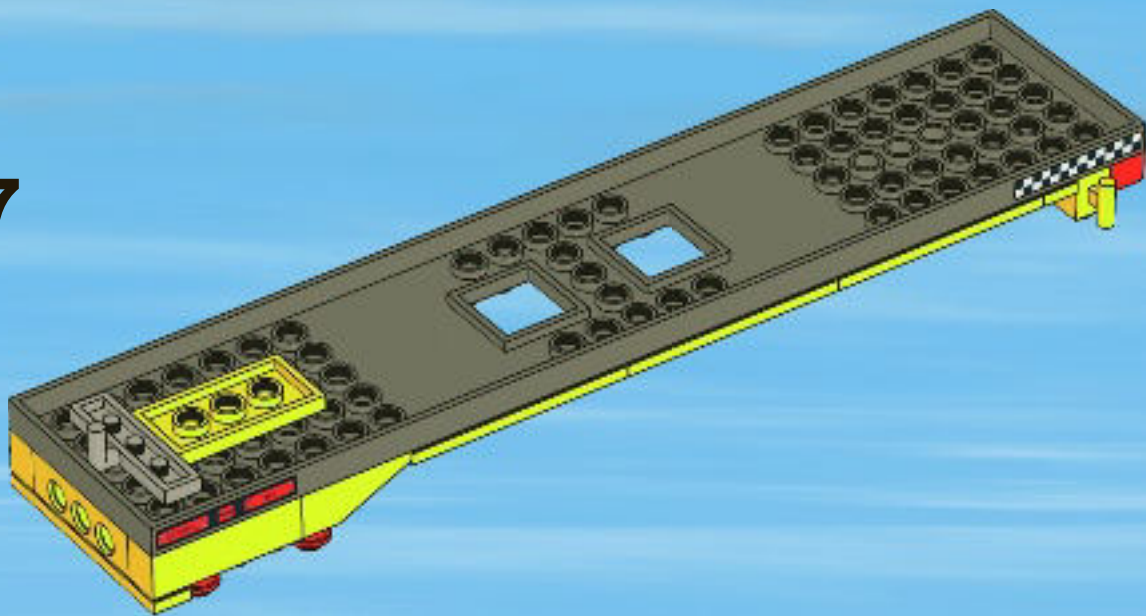



1

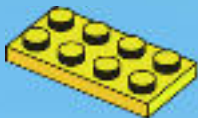

2



3

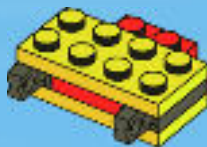

4

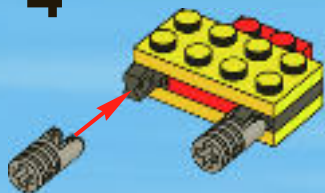

5

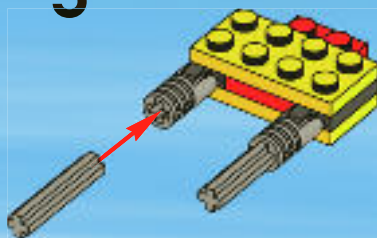

6

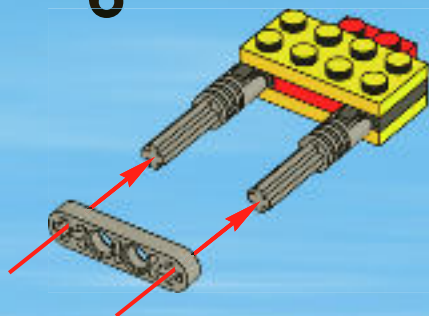

7

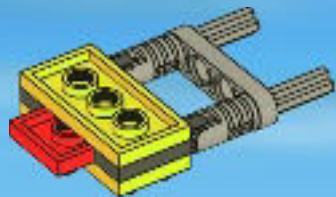

8

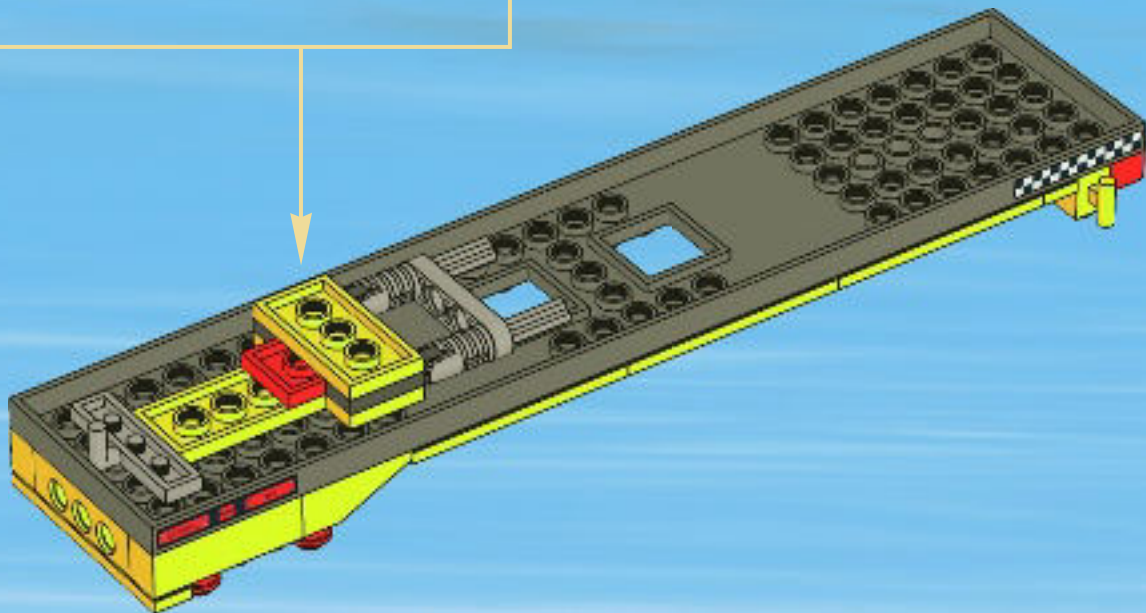



1

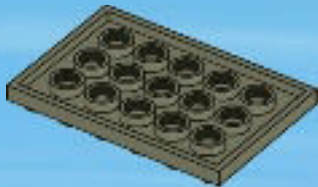

2

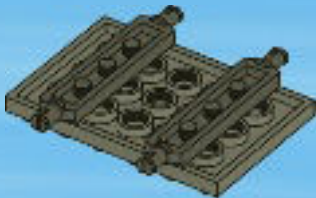

3

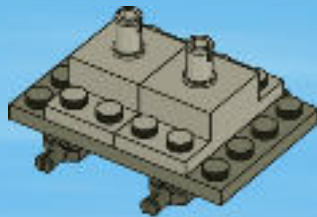

4



5

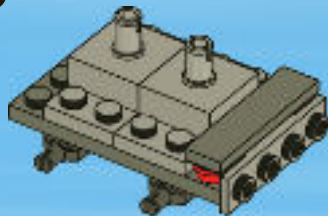

6

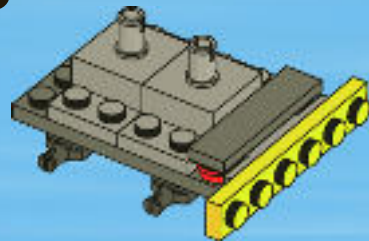

7

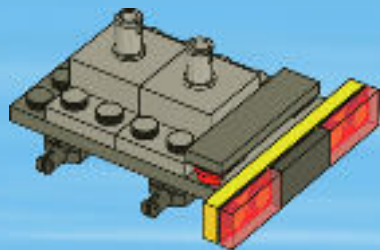

8



9

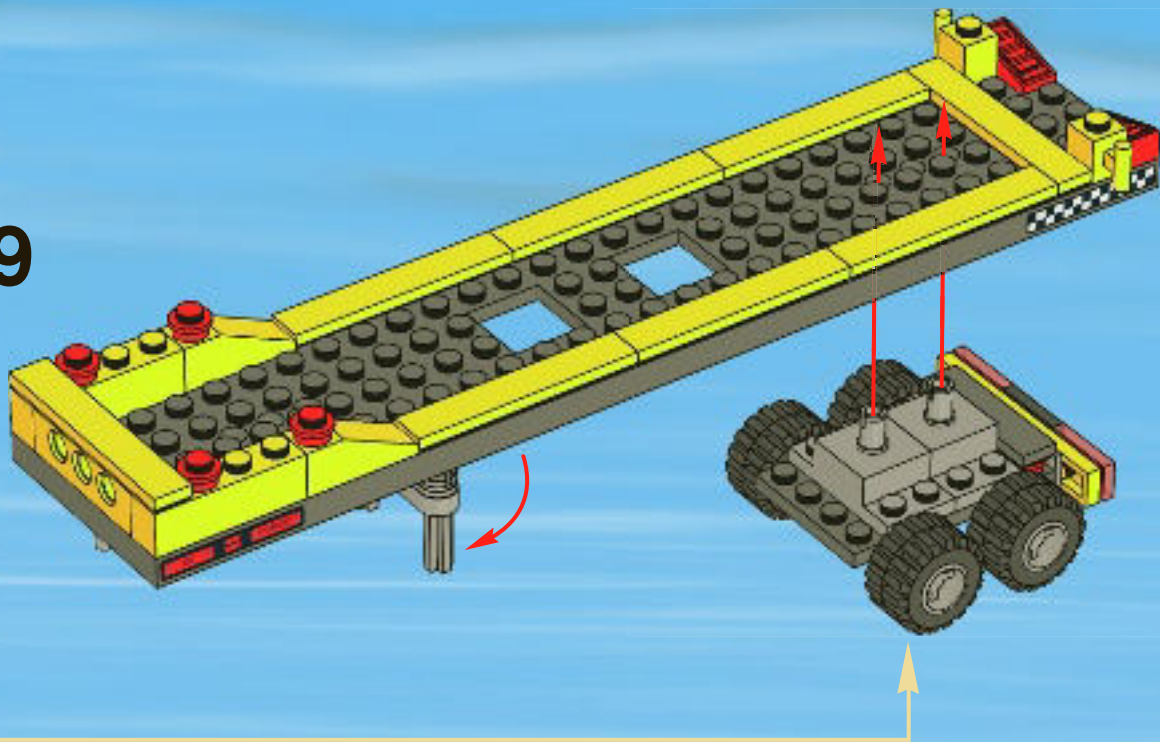

10

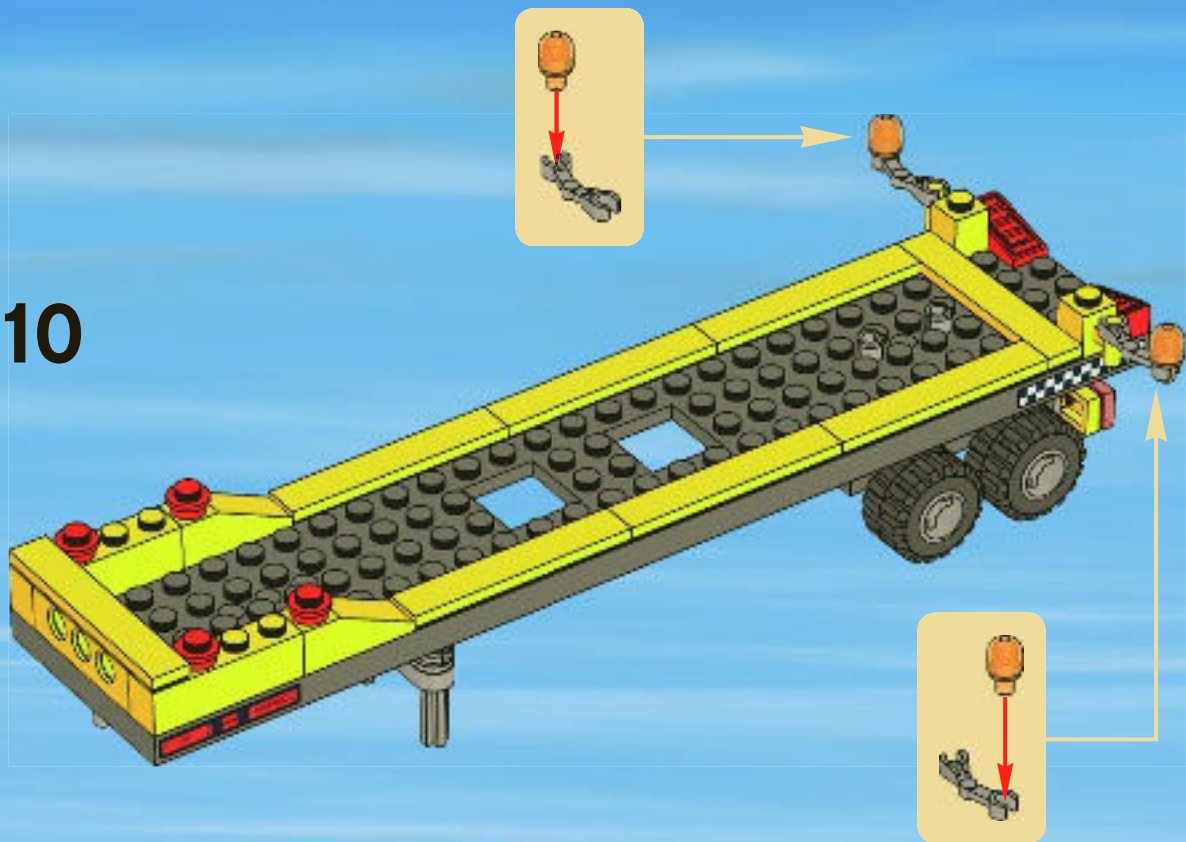



1

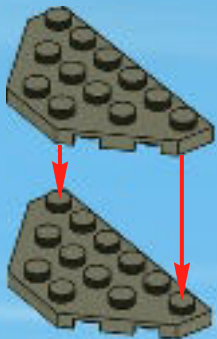

2



3

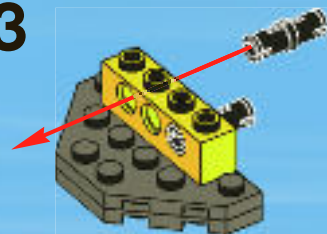

4

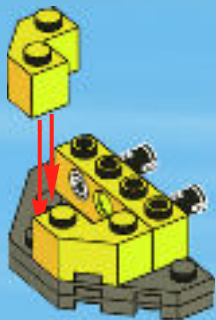

5



6



11

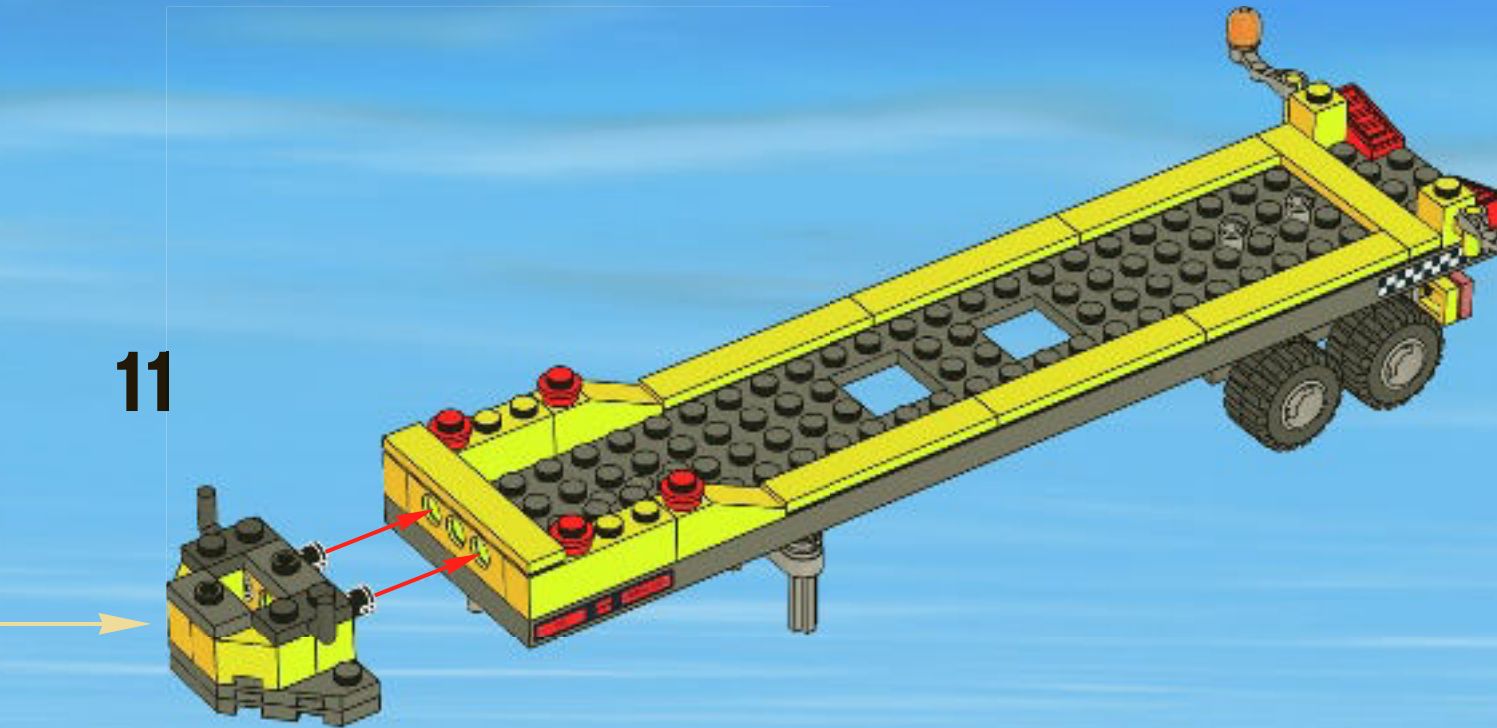



12

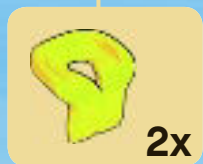
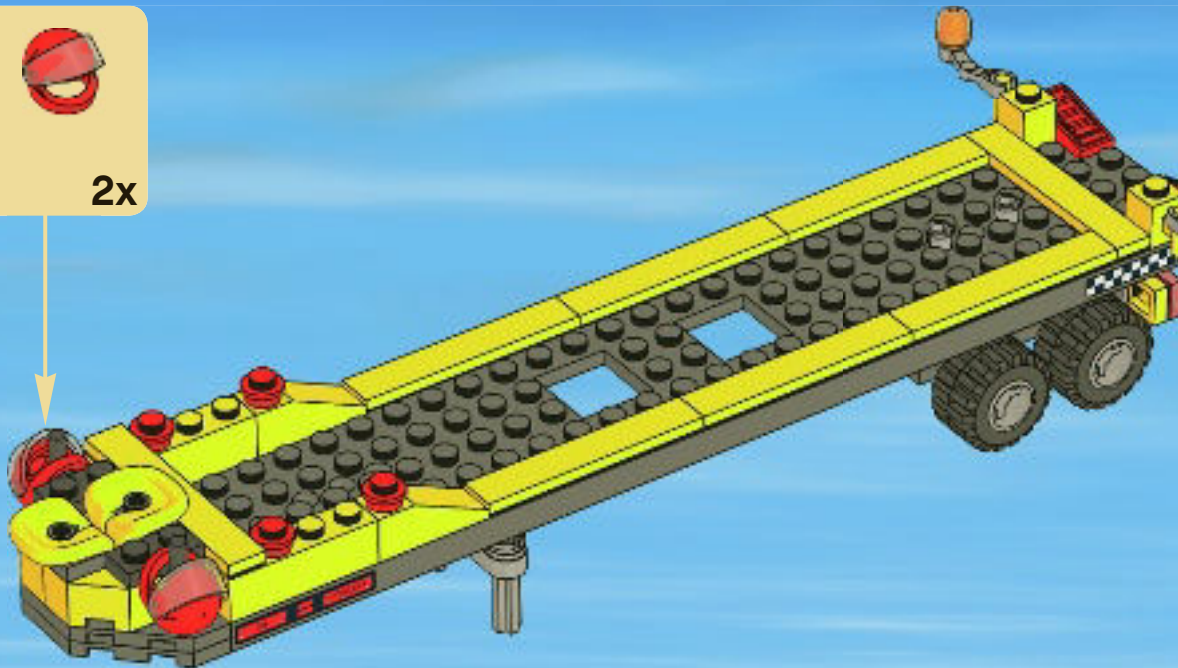

13

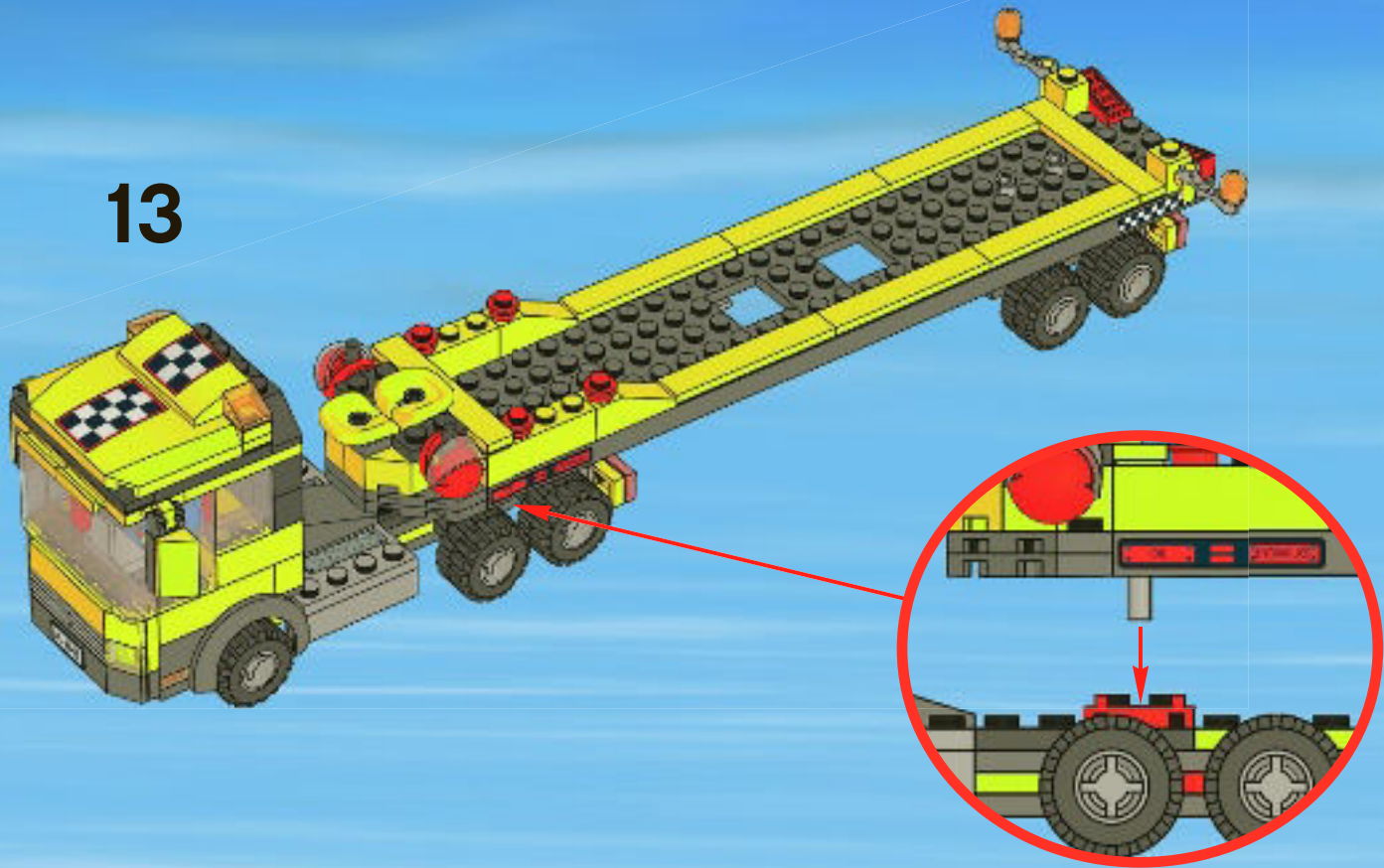

14





CITY



3365



3366



3367



3368



CITY



4641



4642



4643



4644



4645

- 2x 4298617
- 2x 4562544
- 1x 389921
- 2x 300521
- 2x 4504379
- 8x 614121
- 4x 306921
- 2x 4540382
- 2x 302321
- 3x 241221
- 2x 403221
- 1x 4161329
- 1x 4160866
- 1x 407921
- 2x 362321
- 2x 4533742
- 1x 302121
- 2x 366621
- 1x 4113858
- 2x 300921
- 1x 4259903
- 2x 611221
- 2x 4551620
- 1x 4263142
- 1x 4567996
- 1x 300924
- 3x 366624
- 9x 663624
- 2x 4260942
- 4x 4189801
- 2x 4504381
- 2x 307024
- 2x 4262786
- 1x 4261572
- 1x 4570043
- 2x 4540384
- 2x 4550348
- 1x 4243817
- 1x 243124
- 3x 371024
- 3x 302024
- 5x 301024
- 2x 370124
- 1x 300224
- 2x 362224
- 2x 428624
- 1x 4597902
- 1x 4560181
- 2x 302124
- 2x 4581524
- 2x 4260843
- 1x 243224
- 1x 302224
- 2x 4185617
- 2x 4141630
- 2x 4275827
- 2x 9341
- 2x 300526
- 4x 4106347
- 2x 306926
- 2x 4569733
- 1x 300426
- 2x 4121966
- 2x 4121715
- 2x 4183043
- 2x 448826
- 2x 407926
- 10x 4514560
- 2x 4599499
- 2x 4162443
- 4x 370926
- 4x 292626
- 1x 663626
- 2x 4160393
- 1x 300926



1x
4498370



1x
4546689



2x
4163114



2x
4189803



2x
4163306



2x
4244369



2x
4542673



2x
4524365



1x
4211838



1x
4211385



2x
4211666



2x
4211445



2x
4211356



4x
4282740



1x
4211840



1x
4261605



1x
4211645



2x
4222047



2x
4211350



10x
4211764



2x
4226995



2x
4211658



2x
4211815



1x
4211103



1x
4211001



2x
4211053



4x
4211096



2x
4567887



2x
4211119



2x
4210884



1x
4210869



1x
4210872



2x
4504378



1x
4210637



1x
4210794



2x
4260124



7x
4211056



1x
4552248



2x
4210984



2x
4211115

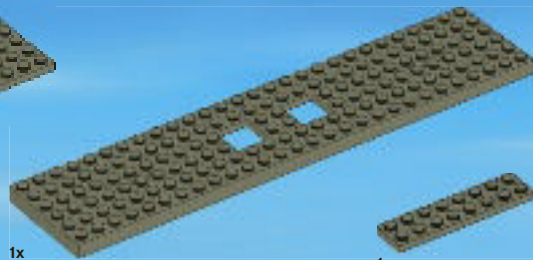

1x
4594647



1x
4210796



1x
4597140



1x
4210997

Customer Service

Kundenservice

Service Consommateurs

Servicio Al Consumidor

www.lego.com/service or dial



: 00800 5346 5555

: 1-800-422-5346

WIN!

Go to www.LEGOsurvey.com/product to fill out a survey for a chance to win a cool LEGO® Product.

No purchase necessary.

Open to all residents where not prohibited.

www.LEGOsurvey.com/product

GEWINNE!

Nimm an der Umfrage auf www.LEGOsurvey.com/product teil und hab die Chance ein cooles LEGO® Produkt zu gewinnen!

Die Teilnahme am Gewinnspiel führt zu keinerlei Kaufverpflichtungen. Teilnahme in allen nicht ausgeschlossenen Ländern möglich.

4631455

WIN!

Ga naar www.LEGOsurvey.com/product, vul een enquêteformulier in en maak kans op een cool LEGO® product.

Geen aankoopverplichting. Iedereen mag deelnemen, uitgezonderd ingezetenden van landen waar een enquêteverbod geldt.

GAGNE!

Visite www.LEGOsurvey.com/product pour répondre à un questionnaire et avoir une chance de gagner un produit LEGO® très cool!

Aucune obligation d'achat. Ouvert à tous les résidents des pays autorisés.

LEGO and the LEGO logo are trademarks of the LEGO Group. ©2011 The LEGO Group.

当てよう!

www.LEGOsurvey.com/product にアクセスして、アンケートにご記入ください。当選者にはレゴ®製品を差し上げます。

お買い上げの必要はありません。禁止されていない限り、すべての皆様にご利用いただけます。